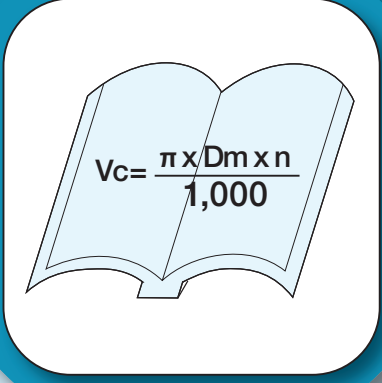

Technical Information

R1~R52

$$V_c = \frac{\pi \times D_m \times n}{1,000}$$

R

General Information

R2~R19

ISO13399 Compliant Dimension Markings	R2
SI Unit Conversion Table / Cutting Symbol	R6
Surface Roughness	R7
Heat Treatment and Hardness Expression	R8
Vickers Hardness Conversion Chart	R9
Material List (JIS)	R10
Material Cross Reference Table	R11

Various Cross Reference Tables

R20~R29

Insert Grades Cross Reference Table	R20
Molded Chipbreaker Cross Reference Table	R26
Milling Insert Description Cross Reference Table	R28

Terms and Angles of Toolholder

R30~R35

Terms and Angles of Turning Toolholder	R30
Terms and Angles of Milling Cutter	R31
Terms of Solid End Mill	R32
Terms of Solid Drill	R33
Caution when Using Wiper Inserts	R34

Trouble shooting

R36~R39

Cutting Edges Figuration and Countermeasures	R36
Turning	R37
Milling	R38
Drilling	R39

Basic Formulas

R40~R43

Basic Formulas (Turning)	R40
Basic Formulas (Milling)	R42
Basic Formulas (Drilling)	R43

Tooling Examples of Small Parts Machining

R44~R51

Tooling Example	R44
Automatic Lathe List by Manufacturer	R46
List of Instruments and Applicable Small Parts Machining and Toolholders	R51

Parts Compatibility of Lever Lock Toolholders

R52

ISO13399 Compliant Dimension Markings

All Dimension Markings in the 2018-2019 General Catalog are Complied with ISO13399. Symbol, Detail and Previous Symbol are shown below.

(1) Insert

Symbol	Detail	Previous Symbol
AN	Relief Angle	α
D1	Hole Diameter	ϕd
IC	I.C. Size	A
RE	Corner-R	$r\epsilon$
S	Insert Thickness	T

(2) Toolholder for External

Symbol	Detail	Previous Symbol
B	Shank Width	B
H	Shank Height	H1
HF	Edge Height	h
LF	Overall length	L1
LH	Head Length	L2
WF	Functional Width	F1

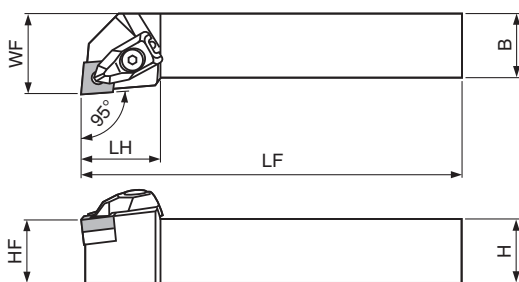
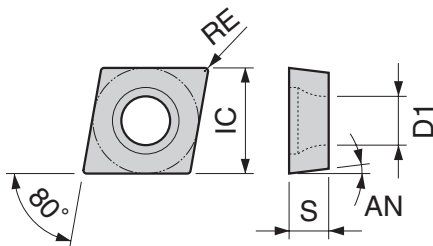
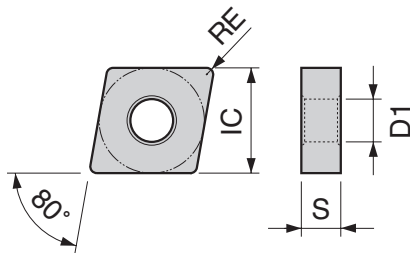

(3) Small Parts Machining

Symbol	Detail	Previous Symbol
B	Shank Width	B
H	Shank Height	H1
HF	Edge Height	h
LF	Overall length	L1
LH	Head Length	L2
LU	Usable Length	L2
WF	Functional Width	F1

(4) Boring Bars

Symbol	Detail	Previous Symbol
DMIN	Min. Bore Dia.	ϕA
DCON	Shank Dia.	$\phi D, \phi D1$
GAMO	Rake Angle	θ
H	Shank Width	H
LF	Overall length	L1
LH	Head Length	L2
LPR	Overall length	L1
LU	Usable Length	L2
RE	Corner-R	$r\epsilon$
WF	Functional Width	F

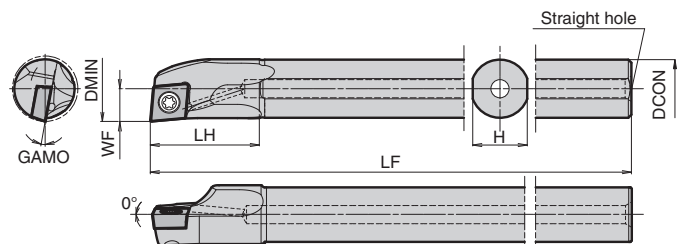
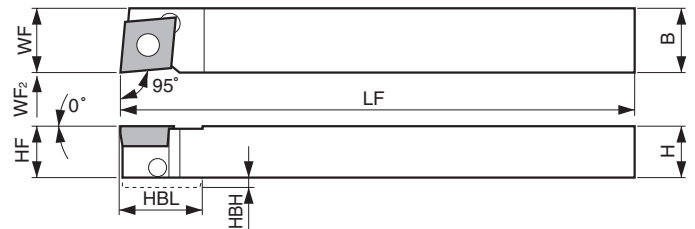

(5) Grooving / Cut-off Inserts

Symbol	Detail	Previous Symbol
IC	I.C. Size	A
BCH	Chamfer width	C
CDX	Max. Cutting Depth	B
CW	Edge Width	W
D1	Hole Diameter	ϕd
DAXN	External dia. of the groove (MAX.)	ϕD
DAXX	External dia. of the groove (MIN.)	ϕD
INSL	Insert Length	L
PSIR $\%_L$	Lead Angle	θ
RE	Corner-R	r_e
S	Insert Thickness	H, T
W1	Insert Width	A

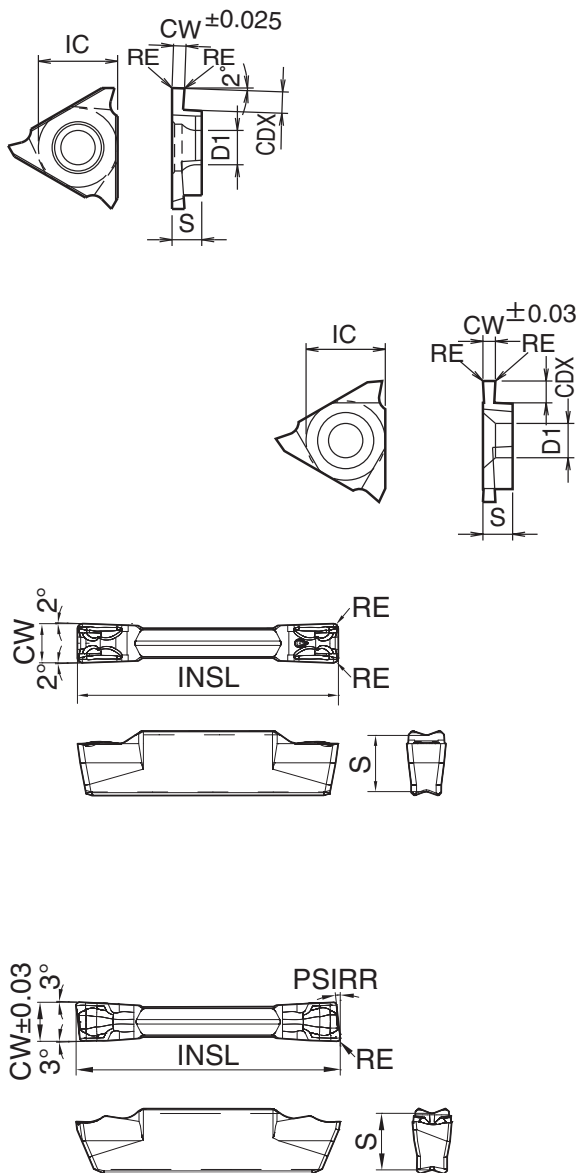

(6) Grooving / Cut-off Toolholders

Symbol	Detail	Previous Symbol
B	Shank Width	B
CDX	Max. Cutting Depth	T
CUTDIA	Max. Cut-off Dia.	ϕD_{max}
DAXN	External dia. of the groove (MAX.)	ϕD
DAXX	External dia. of the groove (MIN.)	ϕD
DCB	Connection Bore Dia. (Sleeve)	$\phi d1$
DMIN	Min. Bore Dia.	ϕA
DCON	Shank Dia.	$\phi D, \phi D1$
H	Shank Height	H1
HF	Edge Height	h
LF	Overall length	L1
LH	Head Length	L2
WF	Functional Width	F1

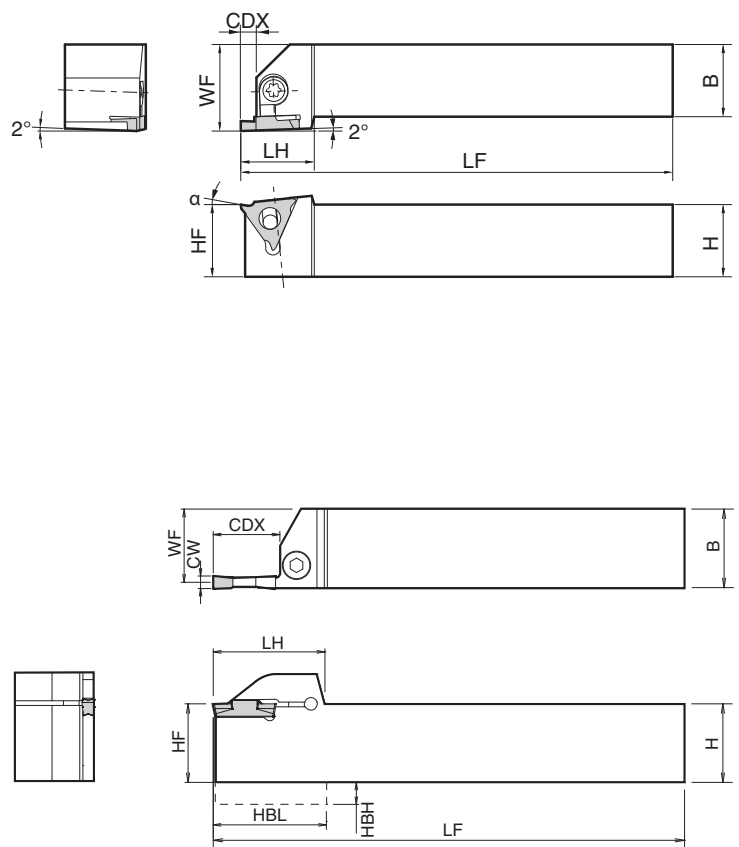

(7) Threading Inserts

Symbol	Detail	Previous Symbol
IC	I.C. Size	A
D1	Hole Diameter	ϕd
PNA	Thread Angle	θ
PDX	Profile Distance	S
S	Insert Thickness	T
RE	Corner-R	$r\epsilon$

(8) Threading Toolholders

Symbol	Detail	Previous Symbol
B	Shank Width	B
DMIN	Min. Bore Dia.	ϕA
DCON	Shank Dia.	ϕD
H	Shank Height	H1
HF	Edge Height	h
LF	Overall length	L1
LH	Head Length	L2
LU	Usable Length	L2
WF	Functional Width	F, F1

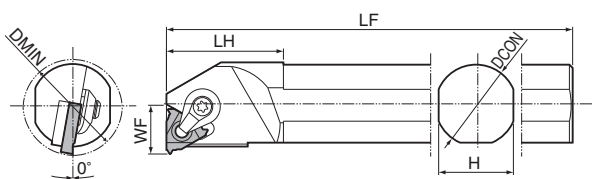
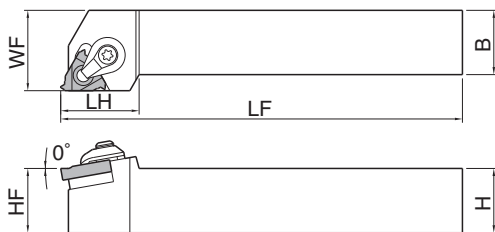
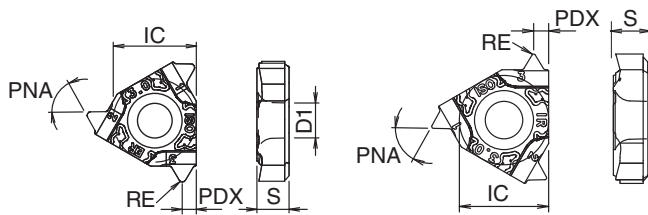

(9) Inserts for Drill

Symbol	Detail	Previous Symbol
IC	I.C. Size	A
D1	Hole Diameter	ϕd
DC	Drill Dia.	ϕDc
PL	Insert Point Length	Lp
RE	Corner-R	$r\epsilon$
S	Insert Thickness	T
INSL	Insert Length	A
W1	Insert Width	W

(10) Drill holder

Symbol	Detail	Previous Symbol
DC	Drill Dia.	ϕDc
DCON	Shank Dia.	ϕDs
OAL	Overall Length	L
LU	Usable Length	L3
PL	Insert Point Length	Lp
LS	Shank Length	Ls
DCSFMS	Flange Dia.	$\phi d1$
LFS	Functional Length	L1
LCF	Flute Length	L2

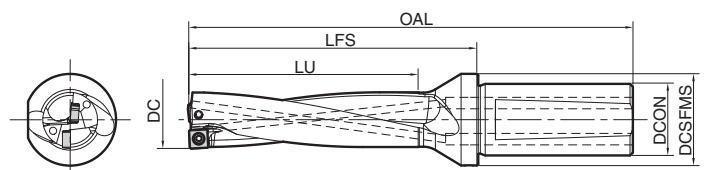
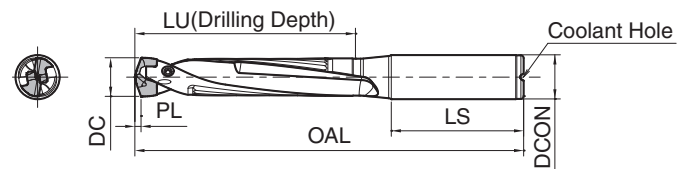
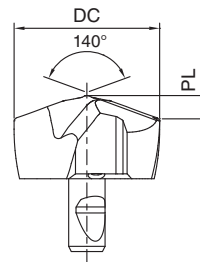
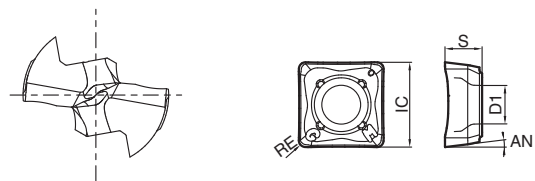

(11) Solid End Mill

Symbol	Detail	Previous Symbol
APMX	Max. Depth of Cut	ℓ
CHW	Chamfer width	C
DC	Cutting Dia.	øDc
DCON	Shank Dia.	øDs
DN	Neck Dia.	øD1
LF	Overall length	L
LU	Under Neck Length	ℓ2
RE	Corner-R	rε, r
ZEFP	No. of Inserts	Z

(12) Solid Drill

Symbol	Detail	Previous Symbol
OAL	Overall length	L
DC	Cutting Dia.	øDc
DCON	Shank Dia.	øDs
LCF	Flute Length	ℓ
LN	Under Neck Length	ℓ2
LS	Shank Length	Ls
LU	Usable Length	ℓe

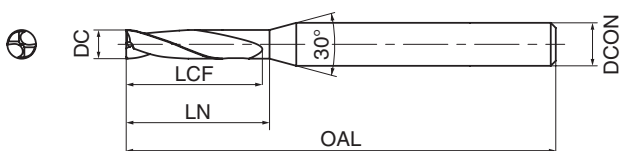
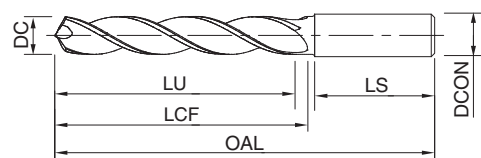
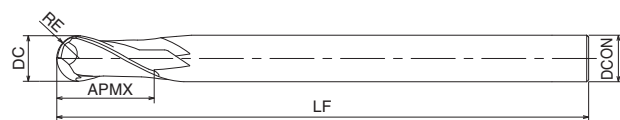
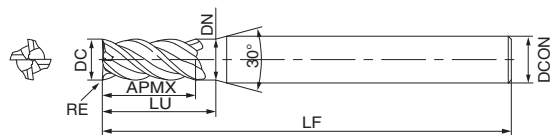

(13) Milling Inserts

Symbol	Detail	Previous Symbol
BCH	Corner Chamfer Length	X
BS	Wiper Edge Width	Z
D1	Hole Diameter	ød
IC	I.C. Size	A
INSL	Insert Length	W
L	Cutting Edge Length	W
RE	Corner-R	rε
S	Insert Thickness	T

(14) Toolholder for Milling

Symbol	Detail	Previous Symbol
APMX	Max. Depth of Cut	S
CBDP	Connection Bore Depth	E
DC	Cutting Dia.	øD
DCB	Bore Dia.	ød
DCON	Shank Dia.	øDs
DCSFMS	Contact Surface Dia.	øD2
DCX	Maximum Cutting Dia.	øD1
KDP	Keyway Depth	a
KWW	Keyway Width	b
LF	Toolholder Height	H
LH	Head Length	ℓ

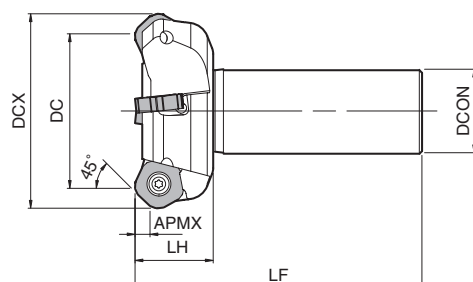
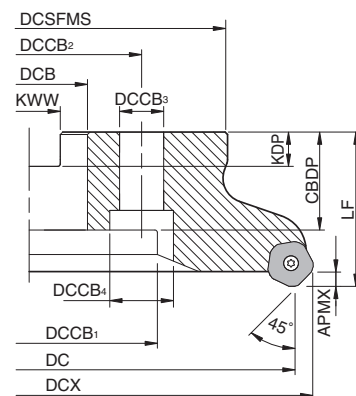
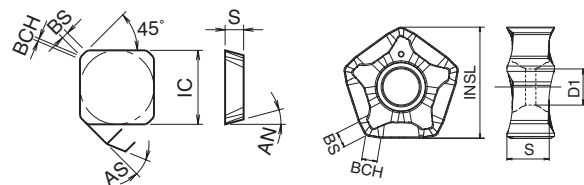

SI Unit Conversion Table / Cutting Symbol

SI Derived Units Conversion Chart

(Bold lined units are the ones by SI Derived Unit.)

(Extracted from JIS Handbook "Iron & Steel")

● Force

N	kgf	dyn
1	$1.019\ 72 \times 10^{-1}$	1×10^5
9.806 65	1	$9.806\ 65 \times 10^5$
1×10^{-5}	$1.019\ 72 \times 10^{-6}$	1

● Stress

1Pa=1N/m², 1MPa=1N/mm²

Pa or N/m ²	MPa or N/mm ²	kgf/mm ²	kgf/cm ²	kgf/m ²
1	1×10^{-6}	$1.019\ 72 \times 10^{-7}$	$1.019\ 72 \times 10^{-5}$	$1.019\ 72 \times 10^{-1}$
1×10^6	1	$1.019\ 72 \times 10^{-1}$	$1.019\ 72 \times 10$	$1.019\ 72 \times 10^5$
$9.806\ 65 \times 10^6$	9.806 65	1	1×10^2	1×10^6
$9.806\ 65 \times 10^4$	$9.806\ 65 \times 10^{-2}$	1×10^{-2}	1	1×10^4
9.806 65	$9.806\ 65 \times 10^{-6}$	1×10^{-6}	1×10^{-4}	1

● Pressure

1Pa=1N/m²

Pa	kPa	MPa	bar	kgf/cm ²
1	1×10^{-3}	1×10^{-6}	1×10^{-5}	$1.019\ 72 \times 10^{-5}$
1×10^3	1	1×10^{-3}	1×10^{-2}	$1.019\ 72 \times 10^{-2}$
1×10^6	1×10^3	1	1×10	$1.019\ 72 \times 10$
1×10^5	1×10^2	1×10^{-1}	1	1.019 72
$9.806\ 65 \times 10^4$	$9.806\ 65 \times 10$	$9.806\ 65 \times 10^{-2}$	$9.806\ 65 \times 10^{-1}$	1

Cutting Symbol

● Cutting conditions below are indicated by the new symbols listed in 2nd column.

1) Turning

Cutting Conditions	Symbol	(Previous Symbol)	Unit
Cutting Speed	Vc	V	m/min
Feed Rate	f	f	mm/rev
Depth of Cut	ap	d	mm
Edge Width	CW	W	mm
Workpiece Dia.	Dm	D	mm
Required Power	Pc	Pkw	kW
Specific Cutting Force	kc	Ks	MPa
Theoretical Surface Roughness	h	Rz	μm
Corner Radius	RE	R	mm
Revolution	n	N	min ⁻¹

3) Drilling

Cutting Conditions	Symbol	(Previous Symbol)	Unit
Cutting Speed	Vc	V	m/min
Feed Speed	Vf	F	mm/min
Feed Rate	f	f	mm/rev
Drill Dia.	DC	D (Ds)	mm
Required Power	Pc	Pkw	kW
Specific Cutting Force	kc	Ks	MPa
Drilling Depth	H	d	mm
Revolution	n	N	min ⁻¹

2) Milling

Cutting Conditions	Symbol	(Previous Symbol)	Unit
Cutting Speed	Vc	V	m/min
Feed Speed	Vf	F	mm/min
Feed per tooth	fz	f	mm/t
Feed Rate	f	f	mm/rev
No. of Inserts	Z	Z	teeth
Depth of Cut	ap	d	mm
Width of Cut	ae	w	mm
Pick feed	Pf	Pf	mm
Required Power	Pc	Pkw	kW
Specific Cutting Force	kc	Ks	MPa
Chip Removal Volume	Q	Q	cm ³ /min
Revolution	n	N	min ⁻¹

Surface Roughness (JIS B 0601-2001)

Theoretical (Geometrical) Surface Roughness

Theoretical surface roughness for turning indicates the minimum roughness value from the cutting conditions and it is shown by the formula as follows.

$$Rz(h) = \frac{f^2}{8R(RE)} \times 10^3$$

Rz(h) : Theoretical Surface Roughness [μm]

f : Feed Rate [mm/rev]

R(RE) : Corner Radius of Insert [mm]

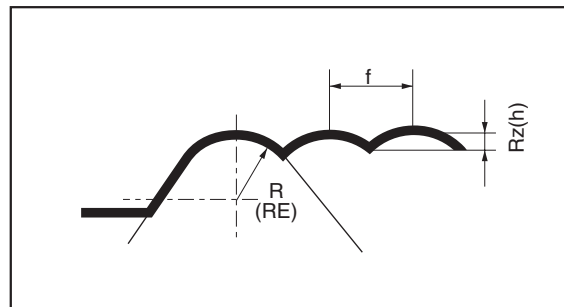

How to Obtain Surface Roughness Values

Type	Symbol	How to Obtain	Explanation
Max. Height Roughness	Rz	Rz is a mean value in micron meter obtained from the distance of the highest peaks and the lowest valleys within the range of sampled reference length (" ℓ ") in the direction of the center line of the roughness curve. Note) When calculating Rz, extraordinarily high or low threads are considered as damages and excluded from the calculation, and only standard lengths are used. Rz=Rp+Rv	
Ten Points Mean Roughness	RzJIS	RzJIS is a mean value in micron meter obtained from the distance of 5 highest peaks (Yp) and the 5 lowest valleys (Yv) measured from the center line of the roughness curve within the range of sampled reference length " ℓ ". $Rz_{JIS} = \frac{(Yp1+Yp2+Yp3+Yp4+Yp5) + (Yv1+Yv2+Yv3+Yv4+Yv5)}{5}$	 Yp1, Yp2, Yp3, Yp4, Yp5 : Distance from the mean line to the highest 5 peaks in the range of sampled reference length " ℓ " Yv1, Yv2, Yv3, Yv4, Yv5 : Distance from the mean line to the lowest 5 valleys in the range of sampled reference length " ℓ "
Arithmetical Mean Roughness	Ra	Ra is obtained from the following formula in micron meter, the roughness curve is expressed by $y=f(x)$, the X-axis is in the direction of the center line and the Y-axis is the vertical magnification of the roughness curve in the range of sampled reference length " ℓ ". $Ra = \frac{1}{\ell} \int_0^{\ell} f(x) dx$	

Relationship with Triangle Symbol

Arithmetical Mean Roughness Ra(μm)	Max. Height Proughness Rz(μm)	Ten Points Mean Roughness RzJIS(μm)	(Triangle Symbol)
0.025	0.1	0.1	▽▽▽▽
0.05	0.2	0.2	
0.1	0.4	0.4	
0.2	0.8	0.8	
0.4	1.6	1.6	▽▽▽
0.8	3.2	3.2	
1.6	6.3	6.3	
3.2	12.5	12.5	▽▽
6.3	25	25	
12.5	50	50	▽
25	100	100	

* Finishing symbol (Triangle s and wave-) was removed from JIS standard in the 1994 Revision.

- How to Indicate
- When Ra is 1.6 μm → 1.6 μm Ra
 - When Rz is 6.3 μm → 6.3 μm Rz
 - When RzJIS is 6.3 μm → 6.3 μm RzJIS

Indication in JIS Standard

Example of Ra Indication		Example of Rz Indication	
(1) When indicating the upper limit only (when upper limit is 6.3 μm Ra)		(1) When indicating the upper limit only indicate surface roughness following the parameter symbol.	
(2) When indicating both lower and upper limit (when upper limit is 6.3 μm Ra, lower limit is 1.6 μm Ra)		(2) When indicating both lower and upper limit indicate surface roughness as (upper limit ~ lower limit) following the parameter symbol.	

Note: The indications of Ra and Rz are different.

Caution-Symbols for Surface Roughness

The above information is based on JIS B 0601-2001. However, some symbols were revised as shown in the right table in accordance with ISO Standard from JIS B 0601-2001 version. Ten Points Mean Roughness (Rz) was eliminated from 2001 version but it still remains as RzJIS reference, since it was popular in Japan.

Type	Symbol of JIS B 0601-1994	Symbol of JIS B 0601-2001
Max. Height Roughness	Ry	Rz
Ten Points Mean Roughness	Rz	(RzJIS)
Arithmetical Mean Roughness	Ra	Ra

Insert Grades
 Turning
 Indexable Inserts
 CNC & PCD Tools
 External
 Small Parts
 Boring
 Grooving
 Cut-off
 Threading
 Drilling
 Solid Tools
 Milling
 Tools for Mill
 Spare Parts
 Technical Information
 Index

A
 B
 C
 D
 E
 F
 G
 H
 J
 K
 L
 M
 N
 P
 R
 T

Heat Treatment and Hardness Expression

Heat Treatment

One of the ways to determine the hardness of steel is the heat treatment and it is classified to 3 types.

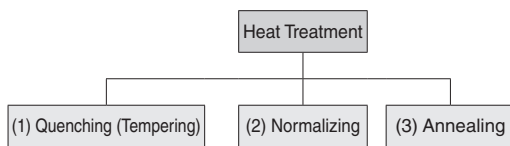

Heat Treatment Method	Detail	Effect
	<ul style="list-style-type: none"> · Quenching (Tempering) After heating to 727°C or over, cool rapidly down to 550°C in water or oil. 	Quenching makes steel hard. Because it cools down red-hot steel very rapidly in water or oil, but it may promote internal stress. In order to remove such internal stress, tempering is used. (After cooled down once, reheat it to 200°C ~ 600°C)
	<ul style="list-style-type: none"> · Normalizing After heating to 727°C or over, cool down rapidly to 600°C and then to normal temperature. 	It miniaturizes the crystals. (Steel is also composed of small cells.) It is used to improve the mechanical character or machinability.
	<ul style="list-style-type: none"> · Annealing After heating to 727°C or over, cool down very slowly to 600°C, then to normal temperature. 	It miniaturizes the crystals like the process of normalizing, but the crystal size is bigger than that of normalizing. It targets machinability improvement and distortion correction.

Hardness Expression

Hardness	Reference Standard	Example	Explanation of Example
Brinell Hardness	JIS Z 2243 : 1992	250HB	Hardness Value : 250, Hardness Symbol : HB
		200 ~ 250HB	When the hardness has the range
Vickers Hardness	JIS Z 2244 : 1998	640HV	Hardness Value : 640, Hardness Symbol : HV
Rockwell Hardness	JIS Z 2245 : 1992	60HRC	Hardness Value : 60, Hardness Symbol : HRC
Shore Hardness	JIS Z 2246 : 1992	50HS	Hardness Value : 50, Hardness Symbol : HS

Vickers Hardness Conversion Chart

Vickers Hardness (HV)	Brinell Hardness 10mm Dia. Ball Load : 3,000kgf (HB)		Rockwell Hardness ²⁾			Shore Hardness (HS)	Tensile Strength MPa ¹⁾
	Standard Ball	Tungsten Carbide Ball	A Scale	B Scale	C Scale		
			Load : 60kgf Diamond Point (HRA)	Load : 100kgf 1.6mm (1/16in) Dia. ball (HRB)	Load : 150kgf Diamond Point (HRC)		
940	-	-	85.6	-	68.0	97	
920	-	-	85.3	-	67.5	96	
900	-	-	85.0	-	67.0	95	
880	-	(767)	84.7	-	66.4	93	
860	-	(757)	84.4	-	65.9	92	
840	-	(745)	84.1	-	65.3	91	
820	-	(733)	83.8	-	64.7	90	
800	-	(722)	83.4	-	64.0	88	
780	-	(710)	83.0	-	63.3	87	
760	-	(698)	82.6	-	62.5	86	
740	-	(684)	82.2	-	61.8	84	
720	-	(670)	81.8	-	61.0	83	
700	-	(656)	81.3	-	60.1	81	
690	-	(647)	81.1	-	59.7	-	2055
680	-	(638)	80.8	-	59.2	80	2020
670	-	630	80.6	-	58.8	-	1985
660	-	620	80.3	-	58.3	79	1950
650	-	611	80.0	-	57.8	-	1905
640	-	601	79.8	-	57.3	77	1860
630	-	591	79.5	-	56.8	-	1825
620	-	582	79.2	-	56.3	75	1795
610	-	573	78.9	-	55.7	-	1750
600	-	564	78.6	-	55.2	74	1705
590	-	554	78.4	-	54.7	-	1660
580	-	545	78.0	-	54.1	72	1620
570	-	535	77.8	-	53.6	-	1570
560	-	525	77.4	-	53.0	71	1530
550	505	517	77.0	-	52.3	-	1495
540	496	507	76.7	-	51.7	69	1460
530	488	497	76.4	-	51.1	-	1410
520	480	488	76.1	-	50.5	67	1370
510	473	479	75.7	-	49.8	-	1330
500	465	471	75.3	-	49.1	66	1290
490	456	460	74.9	-	48.4	-	1240
480	448	452	74.5	-	47.7	64	1205
470	441	442	74.1	-	46.9	-	1170
460	433	433	73.6	-	46.1	62	1130
450	425	425	73.3	-	45.3	-	1095
440	415	415	72.8	-	44.5	59	1070
430	405	405	72.3	-	43.6	-	1035
420	397	397	71.8	-	42.7	57	
410	388	388	71.4	-	41.8	-	
400	379	379	70.8	-	40.8	55	
390	369	369	70.3	-	39.8	-	
380	360	360	69.8	(110.0)	38.8	52	
370	350	350	69.2	-	37.7	-	
360	341	341	68.7	(109.0)	36.6	50	
350	331	331	68.1	-	35.5	-	
340	322	322	67.6	(108.0)	34.4	47	
330	313	313	67.0	-	33.3	-	

Vickers Hardness (HV)	Brinell Hardness 10mm Dia. Ball Load : 3,000kgf (HB)		Rockwell Hardness ²⁾			Shore Hardness (HS)	Tensile Strength MPa ¹⁾
	Standard Ball	Tungsten Carbide Ball	A Scale	B Scale	C Scale		
			Load : 60kgf Diamond Point (HRA)	Load : 100kgf 1.6mm (1/16in) Dia. ball (HRB)	Load : 150kgf Diamond Point (HRC)		
320	303	303	66.4	(107.0)	32.2	45	1005
310	294	294	65.8	-	31.0	-	980
300	284	284	65.2	(105.5)	29.8	42	950
295	280	280	64.8	-	29.2	-	935
290	275	275	64.5	(104.5)	28.5	41	915
285	270	270	64.2	-	27.8	-	905
280	265	265	63.8	(103.5)	27.1	40	890
275	261	261	63.5	-	26.4	-	875
270	256	256	63.1	(102.0)	25.6	38	855
265	252	252	62.7	-	24.8	-	840
260	247	247	62.4	(101.0)	24.0	37	825
255	243	243	62.0	-	23.1	-	805
250	238	238	61.6	99.5	22.2	36	795
245	233	233	61.2	-	21.3	-	780
240	228	228	60.7	98.1	20.3	34	765
230	219	219	-	96.7	(18.0)	33	730
220	209	209	-	95.0	(15.7)	32	695
210	200	200	-	93.4	(13.4)	30	670
200	190	190	-	91.5	(11.0)	29	635
190	181	181	-	89.5	(8.5)	28	605
180	171	171	-	87.1	(6.0)	26	580
170	162	162	-	85.0	(3.0)	25	545
160	152	152	-	81.7	(0.0)	24	515
150	143	143	-	78.7	-	22	490
140	133	133	-	75.0	-	21	455
130	124	124	-	71.2	-	20	425
120	114	114	-	66.7	-	-	390
110	105	105	-	62.3	-	-	-
100	95	95	-	56.2	-	-	-
95	90	90	-	52.0	-	-	-
90	86	86	-	48.0	-	-	-
85	81	81	-	41.0	-	-	-

- Extracted from JIS Handbook "Iron & Steel" (SAE J 417)
 Note 1) 1MPa=1N/mm²
 2) Value in () is not in practical use, but reference only.

Insert Grades
 Turnling
 Indexable Inserts
 CN & PCD Tools
 External
 Small Parts
 Machining
 Boring
 Grooving
 Cut-off
 Threading
 Drilling
 Solid Tools
 Milling
 Tools for
 Turning Mill
 Spare Parts
 Technical
 Information
 Index

A
 B
 C
 D
 E
 F
 G
 H
 J
 K
 L
 M
 N
 P
 R
 T

Material List (JIS)

Ferrous Materials

Classification	Name of JIS Standard	Symbol	
Structural Steel	Rolled Steel for Welded Structure	SM	
	Re-Rolled Steel	SRB	
	Rolled Steel for General Structure	SS	
	Light Gauge Steel for General Structure	SSC	
	Hot-Rolled Steel Plate, Sheet and Strip for Automobile Structural Use	SAPH	
Steel Sheet	Cold-Rolled Steel Plate, Sheet and Strip	SPC	
	Hot-Rolled Soft Steel Plate, Sheet and Strip	SPH	
Steel Pipe	Carbon Steel Pipe for Ordinary Piping	SGP	
	Carbon Steel Pipe for Boiler / Heat Exchanger	STB	
	Seamless Steel Pipe for High Pressure Gas Cylinder	STH	
	Carbon Steel Pipe for General Structural Use	STK	
	Carbon Steel Pipe for Machine Structural Use	STKM	
	Alloy Steel Pipe for Structural Use	STKS	
	Stainless Steel Pipe for Machine Structural Use	SUS-TK	
	Steel Square Pipe for General Structural Use	STKR	
	Alloy Steel Pipe for Ordinary Piping	STPA	
	Carbon Steel Pipe for Pressure Service	STPG	
	Carbon Steel Pipe for High-Temperature Service	STPT	
	Carbon Steel Pipe for High-Pressure Service	STS	
	Stainless Steel Pipe for Ordinary Piping	SUS-TP	
	Machine Structural Steel	Carbon Steel for Machine Structural Use	SxxC,SxxCK
Aluminum Chromium Molybdenum Steel		SACM	
Chromium Molybdenum Steel		SCM	
Chromium Steel		SCr	
Nickel Chromium Steel		SNC	
Nickel Chromium Molybdenum Steel		SNCM	
Manganese Steel and Manganese Chromium Steel for Machine Structural Use		SMn,SMnC	
Special Steel	Tool Steel	Carbon Tool Steel	SK
		Hollow Drill Steel	SKC
		Alloy Tool Steel	SKS,SKD,SKT
		High Speed Tool Steel	SKH
		Free Cutting Carbon Steel	SUM
	Special Steel	High Carbon Chromium Bearing Steel	SUJ
		Spring Steel	SUP
		Stainless Steel Bar	SUS-B
	Stainless Steel	Hot-Rolled Stainless Steel Plate, Sheet and Strip	SUS-HP,SUS-HS
		Cold-Rolled Stainless Steel Plate, Sheet and Strip	SUS-CP,SUS-CS
	Heat-Resisting Steel	Heat-Resisting Steel Bar	SUH-B,SUH-CB
		Heat-Resisting Steel Plate and Sheet	SUH-HP,SUH-CP
	Superalloy	Corrosion-Resisting and Heat-Resisting Superalloy Bar	NCF-B
		Corrosion-Resisting and Heat-Resisting Superalloy Plate and Sheet	NCF-P
Forged Steel	Carbon Steel Forging	SF	
	Chromium Molybdenum Steel Forging	SFCM	
	Nickel Chromium Molybdenum Steel Forging	SFNCM	
Cast Iron	Gray Cast Iron	FC	
	Spheroidal Graphite Cast Iron	FCD	
	Blackheart Malleable Cast Iron	FCMB	
	Whiteheart Malleable Cast Iron	FCMW	
	Pearlitic Malleable Cast Iron	FCMP	
Cast Steel	Carbon Cast Steel	SC	
	High Tensile Strength Carbon Cast Steel & Low Alloy Cast Steel	SCC	
	Stainless Cast Steel	SCS	
	Heat-Resisting Cast Steel	SCH	
	High Manganese Cast Steel	SCMnH	
	Cast Steel for High Temperature and High Pressure Service	SCPH	

Non-ferrous Metals

Classification	Name of JIS Standard	Symbol
Copper	Copper and Copper Alloy Sheet / Strip	CxxxxP
		CxxxxPP
		CxxxxR
	Copper and Copper Alloy Rod and Bar	CxxxxBD
CxxxxBDS		
Aluminum Alloys and Aluminum Alloys Expanded Material	Aluminum and Al. Alloy Sheet / Strip	AxxxxP
		AxxxxPC
	Aluminum and Al. Alloy Rod, Bar, and Wire	AxxxxBE
		AxxxxBES
		AxxxxBD
		AxxxxBDS
		AxxxxW
AxxxxWS		
Aluminum and Al. Alloy Extruded Shape	AxxxxS	
Aluminum and Al. Alloy Forging	AxxxxFD	
Magnesium Alloy Expanded Material	Magnesium Alloy Sheet and Plate	MP
	Magnesium Alloy Rod and Bar	MB
Nickel Alloy	Nickel Copper Alloy Sheet and Plate	NCuP
	Nickel Copper Alloy Rod and Bar	NCuB
Titanium Expanded Material	Titanium Rod and Bar	TB
Casting	Brass Casting	CAC20x
	High Strength Brass Casting	CAC30x
	Bronze Casting	CAC40x
	Phosphoric Bronze Casting	CAC50x
	Aluminum Bronze Casting	CAC70x
	Aluminum Alloy Casting	AC
	Magnesium Alloy Casting	MC
	Zinc Alloy Die Casting	ZDCx
	Aluminum Alloy Die Casting	ADC
	Magnesium Alloy Die Casting	MD
White Metal	WJ	

Material Cross Reference Table

● Steel

Classification	Japan	China	USA	UK	Germany	France	Russia
	JIS	GB	AISI/SAE	BS	DIN	NF	ГОСТ
Carbon Steel for Machine Structural Use	S10C	08 10	1010	040A10 045A10 045M10	C10E C10R	XC10	
	S12C		1012	040A12		XC12	
	S15C	15	1015	055M15	C15E C15R		
	S17C		1017			XC18	
	S20C	20	1020	070M20 C22 C22E C22R	C22 C22E C22R	C22 C22E C22R	
	S22C		1023				
	S25C	25	1025	C25 C25E C22R	C25 C25E C25R	C25 C25E C25R	
	S28C		1029				25Г
	S30C	30	1030	080A30 080M30 C30 C30E C30R	C30 C30E C30R	C30 C30E C30R	30Г
	S33C						30Г
	S35C	35	1035	C35 C35E C35R	C35 C35E C35R	C35 C35E C35R	35Г
	S38C		1038				35Г
	S40C	40	1039 1040	080M40 C40 C40E C40R	C40 C40E C40R	C40 C40E C40R	40Г
	S43C		1042 1043	080A42			40Г
	S45C	45	1045 1046	C45 C45E C45R	C45 C45E C45R	C45 C45E C45R	45Г
	S48C			080A47			45Г
	S50C	50	1049	080M50 C50 C50E C50R	C50 C50E C50R	C50 C50E C50R	50Г
	S53C		1050 1053				50Г
	S55C	55	1055	070M55 C55 C55E C55R	C55 C55E C55R	C55 C55E C55R	
	S58C	60	1059 1060	C60 C60E C60R	C60 C60E C60R	C60 C60E C60R	60Г
S09CK			045A10 045M10	C10E	XC10		
S15CK	15F			C15E	XC12		
S20CK					XC18		

Insert Grades
Turning
Indexable Inserts
CNC & PCU Tools
External
Small Parts
Machining
Boring
Grooving
Cut-off
Threading
Drilling
Solid Tools
Milling
Tools for
Turning Mill
Spare Parts
Technical
Information
Index

A
B
C
D
E
F
G
H
J
K
L
M
N
P
R
T

Material Cross Reference Table

● Steel

Classification	Japan	China	USA	UK	Germany	France	Russia
	JIS	GB	AISI/SAE	BS	DIN	NF	ГОСТ
Nickel Chromium Steel	SNC236				36NiCr6		40XH
	SNC415	12CrNi2			14NiCr10		
	SNC631	30CrNi3			36NiCr10		30XH3A
	SNC815	12Cr2Ni4		655M13	15NiCr13		
	SNC836	37CrNi3			31NiCr14		
Nickel Chromium Molybdenum Steel	SNCM220	20CrNiMo	8615	805A20	20NiCrMo2 20NiCrMoS2	20NCD 2	
			8617	805M20			
			8620	805A22			
			8622	805M22			
	SNCM240		8637 8640		40NiCrMo2-2		
	SNCM415						
	SNCM420	18CrNiMnMoA	4320		17NiCrMo6-4		20XH2M (20XHM)
	SNCM431				30CrNiMo8		
	SNCM439	40CrNiMoA	4340		40NiCrMo6		
	SNCM447				34CrNiMo6		
	SNCM616						
SNCM625							
SNCM630							
SNCM815							
Chromium Steel	SCr415	15Cr			17Cr3		15X
		15CrA			17CrS3		15XA
	SCr420	20Cr	5120				20X
	SCr430	30Cr	5130	34Cr4	34Cr4	34Cr4	30X
			5132	34CrS4	34CrS4	34CrS4	
	SCr435	35Cr	5132	37Cr4	37Cr4	37Cr4	35X
37CrS4				37CrS4	37CrS4		
SCr440	40Cr	5140	530M40	41Cr4	41Cr4	40X	
			41Cr4	41CrS4	41CrS4		
SCr445	45Cr 50Cr					45X	
Chromium Molybdenum Steel	SCM415	15CrMo			15CrMo4		
	SCM418	20CrMo			18CrMo4 18CrMoS4		20XM
	SCM420			708M20	20CrMo5		20XM
	SCM421						
	SCM430	30CrMo 30CrMoA	4130				30XM 30XMA
	SCM432						
	SCM435	35CrMo	4137	34CrMo4	34CrMo4	34CrMo4	35XM
				34CrMoS4	34CrMoS4	34CrMoS4	
SCM440	42CrMo	4140 4142	708M40	42CrMo4	42CrMo4	42CrMoS4	
			709M40	42CrMoS4	42CrMoS4		
			42CrMoS4				
SCM445		4145					
		4147					
SCM822							

● Steel

Classification	Japan	China	USA	UK	Germany	France	Russia
	JIS	GB	AISI/SAE	BS	DIN	NF	ГОСТ
Manganese Steel Manganese Chromium Steel	SMn420	20Mn2	1522	150M19	20Mn5		
	SMn433	30Mn2 35Mn2	1536	150M36	34Mn5		30Г2 35Г2
	SMn438	40Mn2	1541	150M36	36Mn5		35Г2 40Г2
	SMn443	45Mn2	1541				40Г2 45Г2
	SMnC420	15CrMn	5115		16MnCr5		
	SMnC443	40CrMn	5140				
Structural Steel with Specified Hardenability Band	SMn420H		1522H				
	SMn433H						
	SMn438H		1541H				
	SMn443H		1541H				
	SMnC420H						
	SMnC443H						
	SCr415H	15CrH			17Cr3 17CrS3		15X
	SCr420H	20Cr1H	5120H		17Cr3		20X
	SCr430H		5130H 5132H	34Cr4 34CrS4	34Cr4 34CrS3	34Cr4 34CrS4	30X
	SCr435H		5135H	37Cr4 37CrS4	37Cr4 34CrS4	37Cr4 37CrS4	35X
	SCr440H	40CrH	5140H	41Cr4 41CrS4	41Cr4 41CrS4	41Cr4 41CrS4	40X
	SCM415H	15CrMoH	4118H		15CrMo5		
	SCM418H				18CrMo4 18CrMoS4		
	SCM420H	20CrMoH	4118H	708H20	18CrMo4		
	SCM435H		4135H 4137H	34CrMo4 34CrMoS4	34CrMo4 34CrMoS4	34CrMo4 34CrMoS4	
	SCM440H	42CrMoH	4140H 4142H	42CrMo4 42CrMoS4	42CrMo4 42CrMoS4	42CrMo4 42CrMoS4	
	SCM445H		4145H 4147H				
	SCM822H						
	SNC415H						
	SNC631H						
	SNC815H	12Cr2Ni4H			655H13	15NiCr13	
SNCM220H	20CrNiMoH	8617H 8620H 8622H	805H17 805H20 805H22		21NiCrMo2	20N CD 2	
SNCM420H	20CrNi2MoH	4320H			20NiCrMoS6-4		

Insert Grades
Turnling
Indexable Inserts
CNC & PCO Tools
External
Small Parts
Machining
Boring
Grooving
Cut-off
Threading
Drilling
Solid Tools
Milling
Tools for
Turning Mill
Spare Parts
Technical
Information
Index

A
B
C
D
E
F
G
H
J
K
L
M
N
P
R
T

Material Cross Reference Table

● Steel

Classification	Japan	China	USA		UK	Germany	France	Russia
	JIS	GB	UNS	AISI	BS	DIN	NF	ГОСТ
Stainless Steel	SUS 201	1Cr17Mn6Ni5N	S20100	201			Z12CMN17-07Az	
	SUS 202	1Cr18Mn8Ni5N	S20200	202	284S16			12X17Г9AH4
	SUS 301	1Cr18Mn10Ni5Mo3N 1Cr17Ni7	S30100	301	301S21	X12CrNi17 7	Z11CN17-08	07X16H6
	SUS 301L		S30153			X2CrNi18-7		
	SUS 301J1					X12CrNi17 7		
	SUS 302	1Cr18Ni9	S30200	302	302S25		Z12CN18-09	12X18H9
	SUS 302B		S30215	302B				
	SUS 303	Y1Cr18Ni9	S30300	303	303S21	X10CrNiS18 9	Z8CNF18-09	
	SUS 303Se	Y1Cr18Ni9Se	S30323	303Se	303S41			12X18H10E
	SUS 304	0Cr18Ni9	S30400	304	304S31	X5CrNi18 10	Z7CN18-09	08X18H10
	SUS 304L	00Cr18Ni10	S30403	304L	304S11	X2CrNi19 11	Z3CN19-11	03X18H11
	SUS 304N1	0Cr18Ni9N	S30451	304N			Z6CN19-09Az	
	SUS 304N2	0Cr19Ni10NbN	S30452					
	SUS 304LN	00Cr18Ni10N	S30453	304LN		X2CrNi18 10	Z3CN18-10Az	
	SUS 304J1							
	SUS 304J2							
	SUS 304J3		S30431	S30431				
	SUS 305	1Cr18Ni12	S30500	305	305S19	X5CrNi18 12	Z8CN18-12	06X18H11
	SUS 305J1							
	SUS 309S	0Cr23Ni13	S30908	309S			Z10CN24-13	
	SUS 310S	0Cr25Ni20	S31008	310S	310S31		Z8CN25-20	10X23H18
	SUS 316	0Cr17Ni12Mo2	S31600	316	316S31	X5CrNiMo17 12 2	Z7CND17-12-02	
	SUS 316F					X5CrNiMo17 13 3	Z6CND18-12-03	
	SUS 316L	00Cr17Ni14Mo2	S31603	316L	316S11	X2CrNiMo17 13 2	Z3CND17-12-02	
						X2CrNiMo17 14 3	Z3CND17-13-03	03X17H14M3
	SUS 316N	0Cr17Ni12Mo2N	S31651	316N				
	SUS 316LN	00Cr17Ni13Mo2N	S31653	316LN		X2CrNiMoN17 12 2	Z3CND17-11Az	
						X2CrNiMoN17 13 3	Z3CND17-12Az	
	SUS 316Ti		S31635			X6CrNiMoTi17 12 2	Z6CNDT17-12	08X17H13M2T
	SUS 316J1	0Cr18Ni12Mo2Cu2						
	SUS 316J1L	00Cr18Ni14Mo2Cu2						
	SUS 317	0Cr19Ni13Mo3	S31700	317	317S16			
	SUS 317L	00Cr19Ni13Mo3	S31703	317L	317S12	X2CrNiMo18 16 4	Z3CND19-15-04	
SUS 317LN		S31753				Z3CND19-14Az		
SUS 317J1	0Cr18Ni16Mo5							
SUS 317J2								
SUS 317J3L								
SUS 836L		N08367						
SUS 890L		N08904	N08904	904S14		Z2NCDU25-20		
SUS 321	1Cr18Ni9Ti 0Cr18Ni10Ti	S32100	321	321S31	X6CrNiTi18 10	Z6CNT18-10	08X18H10T	
SUS 347	0Cr18Ni11Nb	S34700	347	347S31	X6CrNiNb18 10	Z6CNNb18-10	08X18H12B	
SUS 384		S38400	384			Z6CN18-16		
SUS XM7	0Cr18Ni9Cu3	S30430	304Cu	394S17		Z2CNU18-10		
SUS XM15J1	0Cr18Ni13Si4	S38100				Z15CNS20-12		
SUS 329J1	0Cr26Ni5Mo2	S32900	329					
SUS 329J3L		S39240	S31803			Z3CNDU22-05Az	08X21H6M2T	
SUS 329J4L		S39275	S31260			Z3CNDU25-07Az		

● Steel

Classification	Japan	China	USA		UK	Germany	France	Russia
	JIS	GB	UNS	AISI	BS	DIN	NF	ГОСТ
Stainless Steel	SUS 405	0Cr13Al 0Cr13	S40500	405	405S17	X6CrAl13	Z8CA12	
	SUS 410L	00Cr12					Z3C14	
	SUS 429		S42900	429				
	SUS 430	1Cr17	S43000	430	430S17	X6Cr17	Z8C17	12X17
	SUS 430F	Y1Cr17	S43020	430F		X7CrMoS18	Z8CF17	
	SUS 430LX		S43035			X6CrTi17	Z4CT17	
	SUS 430J1L					X6CrNb17	Z4CNb17	
	SUS 434	1Cr17Mo	S43400	434	434S17	X6CrMo17 1	Z8CD17-01	
	SUS 436L		S43600	436				
	SUS 436J1L							
	SUS 444		S44400	444			Z3CDT18-02	
	SUS 447J1	00Cr30Mo2	S44700					
	SUS XM27	00Cr27Mo	S44627				Z1CD26-01	
	SUS 403	1Cr12	S40300	403				
	SUS 410	1Cr13	S41000	410	410S21	X10Cr13	Z13C13	
	SUS 410S		S41008	410S	403S17	X6Cr13	Z8C12	08X13
	SUS 410F2							
	SUS 410J1	1Cr13Mo 1Cr12Mo	S41025			X12CrS13		
	SUS 416	Y1Cr13	S41600	416	416S21		Z11CF13	
	SUS 420J1	2Cr13	S42000	420	420S29	X20Cr13	Z20C13	20X13
	SUS 420J2	3Cr13	S42000	420	420S37	X30Cr13	Z33C13	30X13
	SUS 420F	Y3Cr13	S42020	420F			Z30CF13	
	SUS 420F2							
	SUS 429J1							
	SUS 431	1Cr17Ni2	S43100	431	431S29	X20CrNi17 2	Z15CN16-02	20X17H2
	SUS 440A	7Cr17	S44002	440A			Z70C15	
	SUS 440B	8Cr17	S44003	440B				
	SUS 440C	9Cr18 11Cr17 9Cr18Mo	S44004	440C			Z100CD17	95X18
SUS 440F	Y11Cr17	S44020	S44020					
SUS 630	0Cr17Ni4CuNb	S17400	S17400		X5CrNiCuNb16-4	Z6CNU17-04		
SUS 631	0Cr17Ni7Al	S17700	S17700		X7CrNiAl17 7	Z9CNA17-07	09X17H7 IO	
SUS 632J1								

● Representative Classification of Stainless Steel

● Stainless Steel (Austenitic related)

JIS	
SUS201	SUS309S
SUS202	SUS310S
SUS301	SUS316
SUS302	SUS316L
SUS302B	SUS316N
SUS303	SUS317
SUS303Se	SUS317L
SUS304	SUS321
SUS304L	SUS347
SUS304N1	SUS384
SUS304N2	SUSXM7
SUS305	SUSXM15J1
SUS308	

● Stainless Steel (Ferritic related)

JIS
SUS405
SUS429
SUS430
SUS430F
SUS434
SUSXM27

● Stainless Steel (Martensitic related)

JIS
SUS403
SUS410
SUS410S
SUS416
SUS420J1
SUS420F
SUS431
SUS440A
SUS440B
SUS440C
SUS440F

● Stainless Steel (Precipitation Hardening)

JIS
SUS630
SUS631

Insert Grades
 Turning
 Indexable Inserts
 CNC & PCO Tools
 External
 Small Parts
 Machining
 Boring
 Grooving
 Cut-off
 Threading
 Drilling
 Solid Tools
 Milling
 Tools for
 Turning Mill
 Spare Parts
 Technical
 Information
 Index

A
 B
 C
 D
 E
 F
 G
 H
 J
 K
 L
 M
 N
 P
 R
 T

Material Cross Reference Table

● Steel

Classification	Japan	China	USA		UK	Germany	France	Russia
	JIS	GB	UNS	AISI	BS	DIN	NF	ГОСТ
Heat-Resisting Steel	SUH 31				331S42		Z35CNWS14-14	45X14H14B2M
	SUH 35				349S52		Z52CMN21-09Az	
	SUH 36	5Cr21Mn9Ni4N	S63008		349S54	X53CrMnNi21 9	Z55CMN21-09Az	55X20 Г 9AH4
	SUH 37	2Cr21Ni12N	S63017		381S34			
	SUH 38							
	SUH 309	2Cr23Ni13	S30900	309	309S24		Z15CN24-13	
	SUH 310	2Cr25Ni20	S31000	310	310S24	CrNi2520	Z15CN25-20	20X25H20C2
	SUH 330	1Cr16Ni35	N08330	N08330			Z12NCS35-16	
	SUH 660	0Cr15Ni25Ti2MoAlVB	S66286				Z6NCTV25-20	
	SUH 661		R30155					
	SUH 21					CrAl1205		
	SUH 409		S40900	409	409S19	X6CrTi12	Z6CT12	
	SUH 409L						Z3CT12	
	SUH 446	2Cr25N	S44600	446			Z12C25	15X28
	SUH 1	4Cr9Si2	S65007		401S45	X45CrSi9 3	Z45CS9	
	SUH 3	4Cr10Si2Mo					Z40CSD10	40X10C2M
	SUH 4	8Cr20Si2Ni			443S65		Z80CSN20-02	
	SUH 11							40X 9C2
SUH 600	2Cr12MoVNbN						20X12BHMБФР	
SUH 616	2Cr12NiMoWV	S42200						

● Representative Classification of Heat-Resisting Steel

● Heat-Resisting Steel (Austenitic related)

JIS
SUH31
SUH35
SUH36
SUH37
SUH38
SUH309
SUH310
SUH330
SUH660
SUH661

● Heat-Resisting Steel (Ferritic related)

JIS
SUH21
SUH409
SUH446

● Heat-Resisting Steel (Martensitic related)

JIS
SUH1
SUH3
SUH4
SUH11
SUH600
SUH616

● Steel

Classification	Japan	China	USA	UK	Germany	France	Russia
	JIS	GB	AISI/ASTM	BS	DIN	NF	ГОСТ
Carbon Tool Steel	SK140 (SK1)	T13				C140E3U	Y13
	SK120 (SK2)	T12	W1-11½			C120E3U	Y12
	SK105 (SK3)	T11	W1-10		C105W1	C105E2U	Y11
	SK95 (SK4)	T10	W1-9			C90E2U	Y10
	SK85 (SK5)	T8Mn T9	W1-8		C80W1	C90E2U C80E2U	Y8Г Y9
	SK75 (SK6)	T8			C80W1	C80E2U C70E2U	Y8
	SK65 (SK7)	T7			C70W2	C70E2U	Y7
High Speed Tool Steel	SKH2	W18Cr4V	T1	BT1		HS18-0-1	P18
	SKH3	W18Cr4VCo5	T4	BT4	S18-1-2-5	HS18-1-1-5	P18K5Φ2
	SKH4	W18Cr4V2Co8	T5	BT5		HS18-0-2-9	P18K5Φ
	SKH10	W12Cr4V5Co5	T15	BT15	S12-1-4-5	HS12-1-5-5	
	SKH51	W6Mo5Cr4V2	M2	BM2	S6-5-2	HS6-5-2	P6M5
	SKH52	CW6Mo5Cr4V2 W6Mo5Cr4V3	M3-1				P6M5Φ3
	SKH53	CW6Mo5Cr4V3	M3-2		S6-5-3	HS6-5-3	P6M5Φ3
	SKH54		M4	BM4		HS6-5-4	
	SKH55	W6Mo5Cr4V2Co5 W7Mo5Cr4V2Co5	M35 M41	BM35	S6-5-2-5	HS6-5-2-5HC	P6M5K5
	SKH56		M36				
	SKH57			BT42	S10-4-3-10	HS10-4-3-10	
SKH58	W2Mo9Cr4V2	M7			HS2-9-2		
SKH59	W2Mo9Cr4VCo8	M42	BM42	S2-10-1-8	HS2-9-1-8		
Alloy Tool Steel	SKS11		F2				XB4
	SKS2				105WCr6	105WCr5	XBГ
	SKS21	W					
	SKS5						
	SKS51		L6				
	SKS7						
	SKS8	Cr06				C140E3UCr4	13X
	SKS4	5CrW2Si 6CrW2Si	S1				6XB2C 5XB2CΦ
	SKS41	4CrW2Si	S1				4XB2C
	SKS43		W2-9½	BW2		100V2	
	SKS44		W2-8				
	SKS3	9CrWMn					9XBГ
	SKS31	CrWMn			105WCr6	105WCr5	XBГ
	SKS93						
	SKS94						
	SKS95	8MnSi					
	SKD1	Cr12	D3	BD3	X210Cr12	X200Cr12	X12
	SKD10	Cr12Mo1V1	D2		X153CrMoV12		X12MΦ
	SKD11	Cr12MoV	D2	BD2	X153CrMoV12	X160CrMoV12	
	SKD12	Cr5Mo1V	A2	BA2		X100CrMoV5	
SKD4					X32WCrV3		
SKD5	3Cr2W8V	H21	BH21	X30WCrV9-3	X30WCrV9		
SKD6	4Cr5MoSiV	H11	BH11	X38CrMoV51	X38CrMoV5	4X5MΦC	
SKD61	4Cr5MoSiV1	H13	BH13	X40CrMoV51	X40CrMoV5	4X5MΦ1C	
SKD62		H12	BH12		X35CrWMoV5	3X3M3Φ	
SKD7	4Cr3Mo3SiV	H10	BH10	X32CrMoV33	32CrMoV12-18		
SKD8		H19	BH19				
SKT3					55CrNiMoV4		
SKT4	5CrNiMo			BH224/5	55NiCrMoV6 55NiCrMoV7	5XHM	

Insert Grades
Turnable Inserts
CNC & PCD Tools
External
Small Parts Machining
Boring
Grooving
Cut-off
Threading
Drilling
Solid Tools
Milling
Tools for Turning Mill
Spare Parts
Technical Information
Index

A
B
C
D
E
F
G
H
J
K
L
M
N
P
R
T

Material Cross Reference Table

● Steel

Classification	Japan	China	USA	UK	Germany	France	Russia
	JIS	GB	AISI/ASTM	BS	DIN	NF	ГОСТ
Spring Steel	SUP3		1075 1078				75 80 85
	SUP6	55Si2Mn			56SiCr7	60Si7	60C2
	SUP7	60Si2Mn 60Si2MnA	9260		61SiCr7	60Si7	60C2Г
	SUP9	55CrMnA	5155		55Cr3	55Cr3	
	SUP9A	60CrMnA	5160		55Cr3	60Cr3	
	SUP10	50CrVA	6150	735A51, 735H51	50CrV4	51CrV4	ХФА50ХГФА
	SUP11A	60CrMnBA	51B60		51CrV4		50ХГР
	SUP12		9254	685A57, 685H57	54SiCr6	54SiCr6	
SUP13	60CrMnMoA	4161	705A60, 705H60	60CrMn3-2	60CrMo4		
Free Cutting Carbon Steel	SUM11		1110				
	SUM12	Y12	1108				
	SUM21		1212				
	SUM22	Y15	1213	(230M07)	9SMn28	S250	
	SUM22L	Y12Pb	12L13		9SMnPb28	S250Pb	
	SUM23		1215				
	SUM23L						
	SUM24L	Y15Pb	12L14		9SMnPb28	S250Pb	
	SUM25				9SMn36	S300	
	SUM31		1117		15S10		
	SUM31L						
	SUM32	Y20		210M15, 210A15		(13MF4)	
	SUM41	Y30 Y35	1137			(35MF6)	
	SUM42	Y40Mn	1141			(45MF6.1)	
SUM43		1144	(226M44)		(45MF6.3)		
High Carbon Chromium Bearing Steel	SUJ1	GCr4	51100				
	SUJ2	GCr15	52100		100Cr6	100Cr6	ШЦХ15
	SUJ3	GCr15SiMn	ASTM A 485 Grade 1				
	SUJ4	GCr15SiMo					
	SUJ5	GCr18Mo					

● Cast Iron

Classification	Japan	China	USA	UK	Germany	France	Russia
	JIS	GB	AISI/SAE	BS	DIN	NF	ГОСТ
Gray Cast Iron	FC100	HT100	NO.20	100	GG10		CY10
	FC150	HT150	NO.30	150	GG15	FGL150	CY15
	FC200	HT200	NO.35	200	GG20	FGL200	CY20
	FC250	HT250	NO.45	250	GG25	FGL250	CY25
	FC300	HT300	NO.50	300	GG30	FGL300	CY30
	FC350	HT350	NO.60	350	GG35	FGL350	CY35
Nodular Cast Iron					GG40	FGL400	CY40
	FCD400	QT400-18	60-40-18	400/17	GGG40	FGS370-17	BY40
	FCD450	QT450-10	65-45-12	420/12		FGS400-12	BY45
	FCD500	QT500-7	70-50-05	500/7	GGG50	FGS500-7	BY50
	FCD600	QT600-3	80-60-03	600/7	GGG60	FGS600-2	BY60
	FCD700	QT700-2	100-70-03	700/2	GGG70	FGS700-2	BY70
	FCD800	QT800-2	120-90-02	800/2	GGG80	FGS800-2	BY80
	QT900-2		900/2			BY100	

● Non-ferrous Metals

Classification	Japan	China	USA	UK	Germany	France	Russia
	JIS	GB	ASTM	BS	DIN	NF	ГОСТ
Aluminum Alloys		1A99	1199		A199.99R		A99
		1A97			A199.98R		A97
		1A95					A95
	A1080	1A80		1080(1A)	A199.90	1080A	A8
	A1050	1A50	1050	1050(1B)	A199.50	1050A	A5
	A5052	5A02	5052	NS4	AlMg2.5	5052	Amg
		5A03		NS5			AMg3
	A5056	5A05	5056	NB6	AlMg5		AMg5V
	A5556	5A30	5456	NG61		5957	
	A2117	2A01	2036		AlCu2.5Mg0.5	2117	D18
	A2017	2A11		HF15	AlCuMg1	2017S	D1
	A2024	2A12	2124		AlCuMg2	2024	D16AVTV
		2B16	2319				
	A2N01	2A80					AK4
	A2018	2A90	2218				AK2
A2014	2A14	2014		AlCuSiMn	2014	AK8	
A7075	7A09	7175		AlZnMgCu1.5	7075	V95P	
Aluminum Alloy Casting	AC4C	ZAlSi7Mn	356.2	LM25	G-AlSi7Mg		
	AC3A	ZAlSi12	413.2	LM6	G-Al12	A-S12-Y4	AL2
		ZAlSi5Cu1Mg	355.2				AL5
	AC8A	ZAlSi2Cu2Mg1	413.0		G-Al12(Cu)		
		ZAlCu5Mn					AL19
		ZAlCu5MnCdVA	201.0				
		ZAlMg10	520.2	LM10	G-AlMg10	AG11	AL8
	ZAlMg5Si			G-AlMg5Si		AL13	

Insert Grades
Turning
Indexable Inserts
CNC & PCO Tools
External
Small Parts
Machining
Boring
Grooving
Cut-off
Threading
Drilling
Solid Tools
Milling
Tools for
Spare Parts
Technical Information
Index

A
B
C
D
E
F
G
H
J
K
L
M
N
P
R
T

Insert Grades Cross Reference Table

CVD Coated Carbide (Turning)

This table is Kyocera's own estimation based on publications and is not authorized by companies mentioned in it.

Classification		Kyocera	Dijet	Mitsubishi Hitachi Tool	Mitsubishi	NTK	Sandvik	Seco	Sumitomo	Tungaloy	Kennametal	Iscar
Classification	Symbol											
P (Steel)	P01	CA510 CA5505	JC110V	HG8010 HC5000 HG3305	UE6105 UE6005 UE6015		GC4305 GC4005 GC4205	TP0501 TP0500 TP1000	AC700G AC810P	T9005 T9105	KCP05B KCP05 KC9105	IC8150 IC9150
	P10	CA510 CA515 CA5505 CA5515	JC110V JC215V	GM10 GM20 GM8015 HG8010	MC6015 UE6105 UE6110 UE6005 UE6010 UE6020	CP2 CP5 CP7	GC4205 GC4015 GC3115 GC4215 GC4315	TP1501 TP1000 TP1500 TP100	AC700G AC2000 AC810P AC820P AC8015P AC8025P	T9005 T9105 T9015 T9115	KCP10B KCP10 KC9010 KC9110	IC8150 IC9150 IC9250
	P20	CA025P CA525 CA5515 CA5525 CR9025	JC110V JC215V	GM20 GM8020 HG8025	MC6025 UC6010 UE6110 UE6020	CP2 CP5 CP7	GC4025 GC4215 GC4220 GC4225 GC4325	TP2501 TP2000 TP2500 TP200	AC2000 AC3000 AC820P AC830P AC8025P	T9015 T9115 T9025 T9125	KCP25B KCP25 KC9125 KC9225 KC9325	IC8250 IC9125 IC9250 IC9350
	P30	CA025P CA525 CA5525 CA530 CA5535 CR9025	JC215V JC325V	GM25 GM8035 HG8025	MC6025 UE6020 MC6035 UE6035 UH6400		GC4225 GC4230 GC4235 GC2135 GC4335	TP2501 TP3501 TP2500 TP2000 TP3500 TP200	AC3000 AC630M AC830P ACP100 AC8035P	T9125 T9035 T9135 T3130	KCP30B KCP30 KC9040 KC9140	IC635 IC8350 IC9350
	P40	CA530 CA5535	JC325V JC450V JC540V	GX30	MC6035 UE6035 UH6400		GC4035 GC4235 GC4240 GC4335	TP40	AC630M AC830P ACP100	T9035 T3130	KCP40B KCP40 KC9140 KC9240	IC635
M (Stainless Steel)	M10	CA6515	JC110V	GM10 HS9105	MC7015 US7020	CP2 CP5	GC2015 GC2220	TP1500 TP100	AC610M AC6020M	T9015 T9115	KCM15B KCM15 KC9010 KC9110 KC9210	IC8250 IC9250 IC9350
	M20	CA6525	JC110V JC215V	GM8020 HG8025 HS9115	US7020 MC7025	CP2 CP5	GC1515 GC2015 GC2025 GC2220	TM2000 TP200	AC6020M AC6030M AC610M AC630M AC830P	T6020 T6120 T9115 T9125	KCM25B KCM25 KC9025 KC9125 KC9225	IC6015 IC8350 IC9250 IC9350
	M30		JC215V JC325V JC525X	GM25 GM8035	MC7025 US735		GC2040 GC235	TM4000 TP3501 TP300	AC6030M AC630M AC830P	T6030 T6130 T9125	KCM35B KCM35 KC9240	IC6025 IC8350 IC9350 IC4050
	M40		JC525X	GX30	US735			TP40			KC9045 KC9245	IC635
K (Cast Iron)	K01	CA310 CA4010 CA4505 CA5505	JC105V JC605X JC605W JC050W	HG3305 HG3315 HX3505 HX3515	MC5005 UC5105 UC5015	CP1	GC3205 GC3210	TK1000 TH1000 TK1001	AC405K AC410K AC300G AC4010K	T5105 T5010	KC9105 KC9315 KCK05B KCK05	IC5005 IC428 IC9007 IC9150
	K10	CA310 CA315 CA4010 CA4115 CA4505 CA4515 CA5505	JC050W JC110V JC605X JC605W JC108W	GM8015 HX3515 HG8010 HG3315	UC5015 UC5105 UC5115 UE6010 MC5015	CP1 CP2 CP5	GC3205 GC3210 GC3215 GC3115	TK1000 TK2000 TK2001 MK1500	AC4010K AC410K AC415K AC700G AC4015K	T515 T5105 T5115 T5010	KC9110 KC9120 KC9315 KCK15B KCK15	IC5010 IC418 IC428 IC9015 IC9007
	K20	CA315 CA320 CA4115 CA4120 CA4515	JC110V JC215V JC605X JC605W	GM8020 HG8025	MC5015 MY5015 UE6010 UC5115 UE6110	CP2 CP5	GC4225 GC3215 GC3220 GC3225	TK2000 TX150 TP200	AC4015K AC420K AC700G AC820P	T515 T5115 T5125 T5020	KC9125 KC9320 KC9325 KCK20B KCK20	IC418 IC9015
	K30	CA320	JC215V	GM25	UE6110		GC3040 GC4335	TP2500 TP200		T5125 T9125	KCP25B KC9320	

PVD Coated Carbide (Turning)

This table is Kyocera's own estimation based on publications and is not authorized by companies mentioned in it.

Classification		Kyocera	Dijet	Mitsubishi Hitachi Tool	Mitsubishi	NTK	Sandvik	Seco	Sumitomo	Tungaloy	Kennametal	Iscar
Classification	Symbol											
P (Steel)	P01	PR1005	JC5003						ACZ150		KC5510	
	P10	PR930 PR1005 PR1025 PR1115 PR1215 PR1425 PR1225	JC5003 JC5030	CY15 CY150 IP2000	MS6015 VP10MF	VM1 TM1 TA1 TAS DT4 DM4	GC1025	CP200	ACZ150 ACZ310 AC520U	AH710	KC5010 KC5510 KU10T	IC507 IC807 IC907
	P20	PR930 PR1025 PR1115 PR1215 PR1425 PR1225 PR1625	JC5015 JC5030 JC5040	CY150 IP2000	MS6015 VP10RT VP15TF VP20MF UP20M VP20RT	QM1 VM1 TA1 TAS	GC1020 GC1025 GC4125 GC1125	CP250	ACZ310 ACZ330 AC520U	AH7025 AH710 AH725 AH730 SH725 SH730	KC5025 KC5525 KC7215 KC7315 KU25T	IC507 IC907 IC908
	P30	PR1025 PR1225 PR1535	JC5015 JC5040	CY250 CY9020 HC844 IP3000	VP10RT VP15TF VP20MF UP20M	ZM3 QM3 TAS	GC1125 GC1145 GC1115 GC1105	CP500	ACZ330 ACZ350 AC530U AC1030U	GH330 AH120 AH740 AH9030	KC7015 KC7020 KC7235 KU25T	IC328 IC928 IC3028
	P40		JC5040	CY250 HC844		ZM3 QM3 TAS	GC1145 GC2145	CP500	ACZ350	AH140 AH740 J740	KC7030 KC7040 KC7140	IC328 IC3028
	M (Stainless Steel)	M10	PR1025 PR1215 PR1225	JC5003	IP050S JP9105	VP10MF VP10RT	VM1 TM1 TA1	GC1005 GC1025 GC1105 GC15	TS2000 CP200 CP250	EH510Z ACZ150 AC510U	AH710	KC5010 KC5510 KC6005 KCU10
M20		PR930 PR1025 PR1125 PR1215 PR1425 PR1225 PR1515	JC5015 JC5030 JC5040 JC8015	IP100S GX30 JP9115	VP10RT VP15TF VP20MF UP20M VP20RT	QM1 VM1 TA1 TAS DT4 DM4	GC1025 GC1115 GC4125 GC1125 GC30	TS2500 CP200 CP250 CP500	EH520Z ACZ150 ACZ310 AC520U AC1030U	AH630 AH725 AH730 GH330 GH730 SH725 SH730	KC5025 KC5525 KC7020 KC7025 KCU25	IC308 IC507 IC907 IC908 IC3028
M30		PR1125 PR1535	JC5015 JC5030 JC5040	CY250 CY9020	VP15TF VP20MF UP20M MP7035	ZM3 QM3 TAS	GC1020 GC2035 GC2030	CP500	ACZ330 ACZ350 AC530U AC6040M	AH6030 AH120 AH725	KC7030 KC7225	IC908 IC1008 IC1028 IC3028
M40					MP7035	ZM3 QM3 TAS	GC2145 GC1145		AC6040M ACZ350	J740 AH140 AH645		IC228 IC928 IC328
K (Cast Iron)	K01		JC5003						EH10Z	AH110	KC5515	IC910
	K10	PR905 PR1215	JC5003 JC5015	CY100H CY10H	VP05RT	TA1 TM1	GC1010	TS2000 CP200	EH10Z EH510Z AC510U	GH110 AH110	KC5010 KC7210	IC807 IC910 IC507 IC908
	K20	PR905 PR1215	JC5015	IP2000 CY9020	VP10RT VP15TF VP20RT	QM1 TA1	GC1020 GC1120	TS2500 CP200 CP250	EH20Z ACZ310 AC520U AC530U AC1030U	AH120 AH725	KC5025 KC5525 KC7015 KC7215 KC7315	IC508 IC908
	K30				VP15TF VP20RT	QM3 TA3	GC1030	CP500	ACZ310		KC7225	IC508 IC908
S (Difficult-to-Cut Material)	S01	PR005S PR1305	JC5003		MP9005 VP05RT					AH8005 AH905		IC806
	S10	PR005S PR015S PR1305 PR1310	JC5015 JC8015	JP9105	MP9005 MP9015 VP10RT		GC1105 GC1005 GC1025	CP200 TS2000	AC510U	AH8015 AH905 SH730 AH110	KC5010 KC5510	IC807 IC808 IC907 IC908
	S20	PR015S PR1310 PR1325 PR1535	JC5015 JC8015	JP9115	MP9015 MT9015 VP20RT		GC1025 GC1125	CP250 TS2500	AC510U AC520U	AH8015 AH120 AH725	KC5025 KC5525	IC806 IC808 IC908
	S30	PR1535			VP15TF		GC1125		AC520U	AH725		IC328

Insert Grades
Turning
Indexable Inserts
CNC & PC Tools
External
Small Parts
Machining
Boring
Grooving
Cut-off
Threading
Drilling
Solid Tools
Milling
Tools for
Turning Mill
Spare Parts
Technical Information
Index

A
B
C
D
E
F
G
H
J
K
L
M
N
P
R
T

Insert Grades Cross Reference Table

Cermet (Turning)

.This table is Kyocera's own estimation based on publications and is not authorized by companies mentioned in it.

Classification		Kyocera	Dijet	Mitsubishi Hitachi Tool	Mitsubishi	NTK	Sandvik	Seco	Sumitomo	Tungaloy	Kennametal	Iscar
Classification	Symbol											
P (Steel)	P01	TN610 TN6010 PV710 PV7010	LN10 CX50	CH350	AP25N VP25N NX1010	T3N T15 Q15			T110A T1000A	NS520 GT530 GT720 J530	KT1120 KT125 HTX	IC20N IC520N
	P10	TN610 TN6010 TN620 TN6020 TN60 PV710 PV7010 PV720 PV7025	LN10 CX50 CX75 NIT PX75	CH350 CZ25	NX2525 AP25N VP25N	T15 C7Z Z15	CT5015 CT525	TP1020 CM CMP	T1500Z T2000Z T1200A T1500A	NS9530 NS520 GT9530 GT530 GT730	KT315 KT175 HT2	IC20N IC520N IC530N IC75T
	P20	TN620 TN90 TN6020 PV720 PV7025	CX50 CX75 CX90 NAT PX90	CH550 CH7030 CZ1025 CZ25	MP3025 NX2525 NX3035 AP25N VP45N	T15 C7X C7Z	CT525 CT530 GC1525	TP1020 C15M TP1030	T1200A T1500A T1500Z T2000Z T3000Z	NS9530 NS530/730 GT9530 GT530/730	PS5 KT5020	IC20N IC520N IC530N IC75T IC30N
	P30		CX90 CX99 SUZ		NX4545 VP45N	N40 C7X	CT530 GC1525	TP1030	T3000Z T250A	NS740		IC75T IC30N
M (Stainless Steel)	M10	TN620 TN60 TN6020 PV720 PV7020 PV7025	LN10	CH350	NX2525 AP25N VP25N	T15 C7X C7Z Z15	CT5015 CT525	CM CMP	T110A T1000A T2000Z	NS520 J530	KT1120 KT315 KT125	IC20N IC520N
	M20	TN620 TN90 TN6020 PV720 PV7020 PV7025	CX50 CX75 PX75 NIT NAT	CH550 CH7030 CZ1025	NX2525 NX3025 AP25N VP25N	C7X C7Z Q15	CT530 GC1525	TP1020 C15M	T1500A T2000Z	NS530 NS730 GT530 GT730	KT175 HT2 PS5 KT5020	IC30N IC530N
	M30		CX75 CX90 PX90 CX99 SUZ	CZ25	NX4545	C7X		TP1030	T3000Z T250A	NS740		
K (Cast Iron)	K01	PV7005	LN10		AP25N VP25N	T3N T15 Q15			T110A T1000A	NS520	KT1120	
	K10	TN610 TN6010 PV710 PV7010 PV7005	LN10	CH350	NX2525 AP25N VP25N	T15 C7X C7Z Z15	CT5015		T1200A T1500A T2000Z	NS530 NS730 GT530 GT730	KT315 HTX	
	K20		NIT	CZ25	NX2525 AP25N VP25N				T3000Z		KT5020	

. Boldface grade shows PVD Coated Cermet.

Carbide

Classification		Kyocera	Dijet	Mitsubishi Hitachi Tool	Mitsubishi	NTK	Sandvik	Seco	Sumitomo	Tungaloy	Kennametal	Iscar
Classification	Symbol											
P (Steel)	P10		SRT	WS10	STi10T		S1P		ST10P	TX10S	K2885	IC70
	P20		SRT DX30	EX35	STi20 UTi20T		SMA	S10M	ST20E	TX20 TX25	K125M	IC70 IC50M
	P30		SR30 DX30 DX35	EX35 EX40	UTi20T		SM30	S25M	A30N A30 ST30E	TX30 UX30	KMF	IC50M IC54
	P40		SR30 DX35	EX45			S6	S60M	ST40E	TX40	PVA	IC54
K (Cast Iron)	K01		KG03	WH02 WH05	HTi05T		H1P		H1 H2	TH03 KS05F	K68 K10	IC04
	K10	KW10 GW15	KG10 KT9	WH10	HTi10	KM1	H1P H10 HM	890	EH10 EH510	G1F TH10 H10T	KMI K8735 K313	IC20
	K20	GW25	CR1 KG20	WH20	HTi20T UTi20T	KM3	H13A	883 890 HX	G10E EH20 EH520	G2F KS15F KS20	KMF	IC20 IC10
	K30		KG30					883	G3 G10E	G3 UX30	THR	IC10 IC28
V (Wear and Shock Resistant Tool)	V40		G5 GD195	WH50	GTi30				G5	D40		
	V50	VW50	MH3 MH4 GD174 GD201	WH60	GTi35 GTi40 GTi30S				G6	D50		
	V60		MH5 MH7 MH8 GD206	WB60	GTi40S GTi50S				G7 G8	D60		

R

Technical Information

Coated Carbide (Milling / Drill)

This table is Kyocera's own estimation based on publications and is not authorized by companies mentioned in it.

Classification		Kyocera	Dijet	Mitsubishi Hitachi Tool	Mitsubishi	NTK	Sandvik	Seco	Sumitomo	Tungaloy	Kennametal	Iscar
Classification	Symbol											
P (Steel)	P10	PR830 PR1025 PR1225	JC5003 JC5030 JC8003	JP4105 JX1020 JP4005	F7010		GC1025 GC1010		ACP100		KC715M	
	P20	PR1525 PR830 PR1025 PR1225 PR1230 CA520D	JC730U JC5015 JC5030 JC8015 JC8118	JP4120 JS4045 JP4020 TB6020 JX1015 GX2140	MP6120 F7030 UP20M	TM1 DT4 DM4	GC1130 GC1030 GC4220 GC4020 GC4030	MP1500 T250M T25M T20M	ACP200	T313W AH725	KC522M KC525M KCPM20	IC330 IC250 IC520M IC950 IC5400 IC1008
	P30	PR1230 PR1535	JC5015 JC5040 JC8050	CY250 CY9020 TB6045 JX1045 JM4060 GX2160	MP6130 F7030 VP15TF VP30RT	ZM3	GC1130 GC4040 GC4230	MP2500 T250M T25M F25M F30M	AC230 ACP300	T3130 GH330 AH120 AH330 AH730 AH3135	KC994M KC725M KC792M KC530M KCPK30 KCPM40	IC330 IC328 IC635 IC830 IC908 IC928
	P40		JC5040	CY250 HC844 TB6060 JX1060	VP30RT		GC4040 GC4240	MP3000 T350M T60M T25M	AC230 ACZ330 ACZ350	AH140	KC735M	IC635 IC928 IC4050
M (Stainless Steel)	M10	PR1025 PR1225		CY9020 JX1020 JP4020	F7010		GC1025 GC1030		ACM100 ACM200 EH10Z		KC522M	
	M20	PR1525 PR1025 PR1225	JC730U JC1341 JC5015 JC5030 JC5040 JC7560	PN215 CY150 TB6020 JX1015 CY250	F7030 UP20M VP15TF VP20RT MP7030 MP7130	DT4 DM4	GC2030	MS2050 MP2500 T250M T25M F20M F25M F30M	ACM200 ACP200 EH20Z	GH330 AH330 AH120 AH130 AH725 AH3135	KC730M KC525M	IC380 IC908 IC928
	M30	CA6535 PR1535	JC5015 JC5030 JC5040 JC7050	JM4160 JM4060 TB6045 JX1045 GX2160	F7030 VP30RT MP7140	ZM3	GC1040 GC2040	T350M T250M F40M	ACM300 ACP300 ACZ350	T3130 AH130	KC994M KC725M KCPK30	IC380 IC328 IC330
	M40		JC8050		VP30RT			MM4500	ACZ350	AH140		IC830
K (Cast Iron)	K01		JC8003	TB6005				MH1000	ACK100	AH110		IC5100 IC4100
	K10	PR1510 PR905 PR1210	JC600 JC610 JC605W	JP4005 CY10H CY100H CY9020	MP8010 MC5020 VP10RT		GC1010 GC3220 K15W	MK1500 T150M F15M	ACK200 AC211	T1015 T1115 AH110 T1215	KCK15 KC915M	IC5100 IC4010 IC910 DT7150 IC810
	K20	CA420M PR905 PR1210 CA415D	JC605X JC610 JC5015 JC8015 JC8118	TH315 CY150 TB6020 JX1015	VP15TF VP20RT		GC1020 GC3020 K20W/K20D GC3330	MP1500 T150M T250M MK2000 MK2050	EH20Z ACZ310 ACK300	AH120 AH725 T1215	KC520M KC920M KC925M KC992M	IC810 IC910 IC928
	K30		JC5080				GC3040 GC4040	MK3000 T250M		GH130	KC930M	IC928
S (Difficult-to-Cut Material)	S10	CA6535 PR1535 PR1210	IC8015 IC5015	PCS08M PTH13S JS1025	MP9120 VP15TF		GC1030 GC1025	MS2050	ACM100 ACM200 ACK300		KC510M	IC903 IC807 IC808 IC908
	S20	CA6535 PR1535 PR1210	IC8015 IC5015 JC8050 JC7560 JC7550	CY100H CY10H	MP9120 VP15TF MP9130 MP9030		GC1030 GC2030 S30T GC1130	MP2050	ACM200		KC525M	IC903 IC807 IC808 IC908 IC830 IC928
	S30	PR1535	JC8050 JC7560				GC2040 S40T	F40M	ACM300		KC725M KCSM40	IC328 IC330

Insert Grades
 Turnable Inserts
 CNV & PCD Tools
 External
 Small Parts
 Machining
 Boring
 Grooving
 Cut-off
 Threading
 Drilling
 Solid Tools
 Milling
 Turning Mill
 Spare Parts
 Information
 Index

Insert Grades Cross Reference Table

Cermet (Milling)

· This table is Kyocera's own estimation based on publications and is not authorized by companies mentioned in it.

Classification		Kyocera	Dijet	Mitsubishi Hitachi Tool	Mitsubishi	NTK	Sandvik	Seco	Sumitomo	Tungaloy	Kennametal	Iscar
Classification	Symbol											
P (Steel)	P10	TN60 TN620M	NIT CX75	CH550	NX2525			C15M		NS530 NS730	KT530M KT195M	
	P20	TN620M TN100M TN60	NAT CX75 CX90	CH570 CH7030 MZ1000	NX2525 MX3020	C7X C7Z	CT530	C15M MP1020	T250A T1500A	NS530 NS730 NS740	HT7 KT530M KT605M	IC30N
	P30		CX90 CX99 SC30	CH7035	NX4545 MX3030				T4500A	NS540		IC30N
M (Stainless Steel)	M10	TN60 TN620M			NX2525			C15M				
	M20	TN620M TN100M TN60	NIT CX75 NAT	CH550 CH570 CH7030	NX2525		CT530	C15M	T250A	NS530	KT7 KT530M KT605M	IC30N
	M30		CX75 CX90 CX99 SC30		NX4545				T4500A	NS740 N308		
K (Cast Iron)	K01		LN10									
	K10		LN10 CX75	CH550	NX2525							IC30N
	K20		NIT	CH7030 CH7035	NX2525							

Ceramic

Classification		Kyocera	Dijet	Nippon Tungsten	Mitsubishi	NTK	Sandvik	Seco	Sumitomo	Tungaloy	Kennametal	Iscar
Classification	Symbol											
K (Cast Iron)	K01	KA30 A65 KT66 PT600M CS7050		NPC-H2 NPC-A2		SE1 HC1 HC2 HC5 HC6 HW2	CC620 CC650		NB90S NB90M WX120		KW80 KY1615 AC5	
	K10	A65 KT66 A66N PT600M CS7050 KS6050		NX NXA Whiskal WIN		WA1 HC2 HC6 HC7	CC6090 CC6190 GC1690		WX120 NS260C	LX11 LX21	KYK10 KYK25 KB90 KY1320 KY3000 KY3400	
	K20	KS6050				SX6 SX9 SP9	CC6090 CC6190 GC1690		WX120	WG300 FX105 CX710	KYK35 KY3400 KY3500	
S (Difficult-to-Cut Material)	S01						CC650				KY2100	
	S10	CF1 KS6030 KS6040	CA200	Whiskal WIN		WA1 WA5 SX3 SX7 SX9	CC670 CC6060 CC6065 CC6160		WX120	WG300	KYS25 KY4300 KY1525 KY1540	IS25
	S20								WX120		KYS30	IS35
H (Hard Materials)	H01	A65 KT66 A66N PT600M		NPC-A2		HC4 HC7 ZC7	CC650 CC670 CC6050		NB100C	LX11 LX21	KY4400	
	H10	A65 KT66 A66N PT600M		NPC-A2 Whiskal WIN		ZC7 WA1 WA5	CC670			WG300	KY4300	

· **Boldface** grade shows PVD Coated Ceramic.

CBN

.This table is Kyocera's own estimation based on publications and is not authorized by companies mentioned in it.

Classification	Kyocera	Dijet	Mitsubishi Hitachi Tool	Mitsubishi	NTK	Sandvik	Seco	Sumitomo	Tungaloy	Kennametal	Iscar	
Classification	Symbol											
K (Cast Iron)	K01	KBN475	JBN795		MB710	B20 B22 B30	CB7525 CB50 CB7050	CBN050C CBN300P	BN500 BNC500	BX910 BX930 BX950	IB50 IB85	
	K10	KBN60M KBN900	JBN330	BH200	MB710 MB5015 MB4020	B22 B23	CB50 CB7050	CBN20 CBN200 CBN300	BN600 BN700 BN7000	BX950 BXC90 BX470	KB1630 KB1345 KB9610	IB55 IB90
	K20	KBN900		BH250	MB730 MBS140 BC5030	B16 B40		CBN350 CBN500 CBN600	BN7000 BNS800	BX950 BXC90 BX90S	KB9640	
H (Hard Materials)	H01	KBN510 KBN05M KBN10M	DH102		BC8105 BC8110 MBC010 MB810	B24 B52 B5K	CB20	CBN050C CBN010 CBN10 CBN100	BN1000 BNX10 BNC100 BNC160 BNC2010	BXA30 BX310 BXC30 BXM10	KB1610	IB20H IB25HC IB50
	H10	KBN510 KBN525 KBN05M KBN10M KBN25M	JC6102 JC8003 JBN500 JBN300 JBN330	BH200	BC8120 MBC020 BC8020 MB8025 MB825	B24 B36 B54 B52 B5K	CB7015 CB7050 CB50 CB7105	CBN150 CBN060K CBN200 CBN160C	BNC160 BNX20 BN2000 BNC200 BNC2020	BXM10 BXA40 BX330 BX360 BXC50 BXA20	KB1615 KB1625 KB5610 KB9610	IB50
	H20	KBN25M KBN30M KBN35M KBN900	JC8003 JC5015 JBN245	BH250	BC8120 MBC020 BC8020 MB8025	B22 B36 B6K	CB7025 CB7525 CB7115	CBN350 CBN300P CBN400C CBN500 CH2540	BNX25 BN350 BNC300	BX380 BXC50 BXM20 BXA20	KB1340 KB5625 KB9640	IB55 IB25HA
	H30	KBN30M KBN35M KBN900	JBN245	BH250	MB835 BC8130	B40 B6K	CB7525	CH3515	BNC300 BN350	BX380 BXC50 BXM20 BXA20	KB5630 KB9640	IB55 IB25HA
Sintered Steel	-	KBN65B KBN570 KBN65M KBN70M	JBN795 JBN500		MB4020			CBN200	BN350 BN7000 BN7500	BX450 BX470 BX480	KB5630	

- **Boldface** grade shows PVD Coated CBN.

PCD

Classification	Kyocera	Dijet	Mitsubishi Hitachi Tool	Mitsubishi	NTK	Sandvik	Seco	Sumitomo	Tungaloy	Kennametal	Iscar	
Classification	Symbol											
N (Non-ferrous Metals)	N01	KPD001	JDA30 JDA735		MD205	PD1	CD05 CD10	PCD05 PCD10	DA90 DA1000 DA2200	DX180 DX160	PD100 KD1400 KD1405	
	N10	KPD001 KPD010 KPD230 KPD250	JDA40 JDA745		MD220	PD2	CD10	PCD10 PCD20	DA150 DA1000 DA2200	DX140	KD100 KD1400 KD1415	ID5
	N20	KPD001 KPD010 KPD230 KPD250	JDA10 JDA715		MD230			PCD30 PCD30M	DA1000 DA2200	DX110 DX120	KD1425	

Insert Grades
Turning
Indexable Inserts
CBN & PCD Tools
External
Small Parts
Machining
Boring
Grooving
Cut-off
Threading
Drilling
Solid Tools
Milling
Tools for
Turning Mill
Spare Parts
Technical Information
Index

A
B
C
D
E
F
G
H
J
K
L
M
N
P
R
T

Molded Chipbreaker Cross Reference Table

Molded Chipbreaker Cross Reference Table

Negative Inserts

-This table is Kyocera's own estimation based on publications and is not authorized by companies mentioned in it.

Cutting Range		Kyocera		Dijet	Mitsubishi Hitachi Tool	Mitsubishi	NTK	Sandvik	Seco	Sumitomo	Tungaloy	Kennametal	Iscar
		General Chipbreaker	Chipbreaker for Sticky Material / Soft Steel										
Carbon Steel / Alloy Steel	Finishing (With Wiper Edge)	WF WP	-	-	-	SW	-	WL WF	W-MF2	SEW LUW	AFW FW	FW	-
	Finishing - Medium (With Wiper Edge)	WE WQ	-	-	-	MW	-	WM WMX	W-M3 W-M5	GUW	ASW SW	MW	WG
	Finishing	DP GP PP	XF XP	F1 FA FT PF	BE BH FE	F FH FS FY PK FP	UL WM ZF1	XF QF	FF1	FP FB FE SP FA FL LU	TF 01 AS TSF	FF UF FS LF	F3P SF
	Finishing - Medium	HQ PQ CQ CJ VC VF	XQ	UA UT	AB B CE CT	SH C SA LP SY	WV WR	LC PF	FF2 MF2	SU EX SJ SX UJ SE	TS NS CB 11 17 27 ZF	RP FN FM	NF
	Medium - Roughing	PG GS PS	XS	UR UB	AE DE AH	MV MP MA MH	Z5 ZW1	XM QM SM SMC PM PMC	M3 MF3	UA UG GE GU	AM DM NM TM ZM	MN	M3P TF
	Medium - Roughing High Feed Rate	PT GT	-	GC PQ	AR AY	GH RP	GS	MR XMR	M5 MR5 MR6	MU UX ME	TH 32Y 32 37	RP RN	R3P NR
	Roughing	Standard PH	-	GG LG GQ	RE	MT Standard	G	Standard 23	MR7	MC MU MX UZ	31 33 F-K THS	PR MG	GN
	Roughing Single Sided High Feed Rate	PX	-	GS RM UC UP UD	H HX HE TE UE	HV HR HX HZ HL HM	-	QR PR HR	R4 R5 R6 R7 RR6 RP	HG HP MP HF	TU TRS 57 65 TUS	RP RH RM RW	TNM
Stainless Steel, Difficult-to-Cut Material	Finishing	MQ SQ	-	SF	BH MP	FS SH FJ LM LS	ZF1	MF	-	SU EF	SF SS	FP	F3M
	Medium - Roughing	MS MU TK SX	-	GP SZ	DE SE PV VI	MS MA GM MJ MM ES MH GH GJ RM RS	ZP WS	MM MMC MR XMR SM SMR SF SGF SMC	MF1 MF3 A3 A5 M5 56 R8 RR9	EG EX MU UP EM	HMM SM SA S SH HRM HPF	P MP MS	TF PP M3M R3M
Cast Iron	Medium	KQ KG C Standard	-	-	AH VA VY	LK MF Standard	-	KF KM	-	UZ UX UJ	Standard 33 CF	FN	-
	Roughing	KH GC ZS	-	-	-	GH RK	-	KR KRR	-	GZ	CM CH	RP UN	-
Non-ferrous Metals	Medium - Roughing	AH	-	-	-	-	-	AL	95	AG	P	GP MS	PP

● Positive Inserts

Cutting Range	Kyocera		Dijet	Mitsubishi Hitachi Tool	Mitsubishi	NTK	Sandvik	Seco	Sumitomo	Tungaloy	Kennametal	Iscar	
	General Chipbreaker	Chipbreaker for Sticky Material / Soft Steel											
Carbon Steel / Alloy Steel	Minute ap	CF	-	-	-	-	-	-	-	01	-	-	
	Finishing (With Wiper Edge)	WP	-	-	-	SW	-	WF WK	W-F1	LUW SDW	SW	FW	WF
	Finishing	PF DP GP PP VF	XP	ASF	-	FV SQ FP SMG	AZ3 AMX AZ7	PF UF XF	FF1	FB FC FK FP LU	PF PSF 23	11 GF UF FP	PF SM
	Finishing - Medium (1)	HQ	XQ	ACB FT	JE	MQ MV LP	AF1	PM UM SMC	F1	LB SF SU	PS PSS 24	LF	14
	Finishing - Medium (2)	GK	-	BM	JQ	No Indication	QD CL	PF PM XM	MF2	-	-	-	-
	Medium	Standard	-	-	J	MP Standard	AM3	PR UR KM XR	F2	MU SC	PM	GM MP MR	Standard
Stainless Steel, Difficult-to-Cut Material	Finishing - Medium	MQ	-	-	MP	FM FV SV LM LS MS	-	MF MMC SM	-	LU	PSS JS PF PSF PS PM	FW FP MW	WF
Non-ferrous Metals	Finishing - Medium	AP AH	-	ALU	-	AZ	-	AL	AL	AG AW	AL	HP	AF AS

● Positive Inserts (for Automatic Lathe)

Cutting Range	Kyocera	Dijet	Mitsubishi Hitachi Tool	Mitsubishi	NTK	Sandvik	Seco	Sumitomo	Tungaloy	Kennametal	Iscar	
Carbon Steel / Alloy Steel	Minute ap	CF	-	-	-	-	-	-	01	-	-	
	Finishing	PF CK GF	ASF	JQ	FP FV SMG	AZ7 AMX ZR	PF XF	FF1	SI FC	PF	11 UF FP	PF SM
	Finishing - Medium	GQ SK LD	ACB FT	JE	LP AM MV	AM3 YL	PM XM	F1 MF2	SU	PS	LF	14
	Medium	GK	-	J	MP Standard	QD CL	PR	F2	SC	PM	MF MP	Standard
Stainless Steel	Finishing	MQ	-	MP	FM FV SV LM	-	MF	-	LU	JS PF PSF	FW FP MW	WF
Non-ferrous Metals	Finishing - Medium	AP AH	ALU	-	AZ	-	AL	AL	AG AW	AL	HP	AF AS

Insert Grades
Indexable Inserts
Turning
CNC & PCO Tools
External
Small Parts
Machining
Boring
Grooving
Cut-off
Threading
Drilling
Solid Tools
Milling
Tools for Turning Mill
Spare Parts
Technical Information
Index

A
B
C
D
E
F
G
H
J
K
L
M
N
P
R
T

Milling Insert Description Cross Reference Table

Milling Insert Description Cross Reference Table

This table is Kyocera's own estimation based on publications and is not authorized by companies mentioned in it.

Kyocera	Class	Applications	Mitsubishi Hitachi Tool	Mitsubishi	Sandvik	Sumitomo	Tungaloy	Iscar
SDMR1203AUER-H SDKR1203AUEN-S	M K		SDKR42TN	(SDNR1203AEEN-JS)		SDMR1203AEEN SDMR1203AETN	SDMR1203AETN-MJ SDKR1203AESR-MJ SDKR1203AETN-MJ SDKR1203AEPN-MS SDKR42ZSR-MJ SDKR42ZPN-MS	SDKR1203AUTR-HS SDKR1203AUN-76
SDCN1203AUTN	C	Steel	(SDE42TN-C9)				SDCN1203AETN-12 SDCN42ZTN (SDEN1203AETNCR) (SDEN42ZTNCR)	
SDKN1203AUTN	K		SDK42TN-C9	SDKN1203AEN SDKN1203AETN (SDNN1203AETN1)		SDKN42MT (SDNN1203AETN)	SDKN1203AETN-12 SDKN42ZTN	SDKN1203AETN
SDKN1203AUFN	K	Cast Iron	SDK42FN-C9			SDKN42M (SDNN1203AEEN)	SDKN1203AEFN-12 SDKN42ZFN	
		Non-ferrous Metals				SDKN42M	(SDCN1203AEFN-D) (SDCN42ZFN-DIA)	
SDKN1504AUTN	K	Steel	SDK53TN-C9	SDKN1504AEN SDKN1504AETN		SDKN53MT	SDKN1504AETN SDKN53ZTN	SDKN1504AETN
SEMR1203AFER-H SEKR1203AFEN-S	M K		SEKR42TN	(SEER1203AFEN-JS)	SEKR1203AZ-WM (SEER1203AZ-WL)	SEMR1203AFEN (SEER1203AFEN)	SEMR1203AFTN-MJ SEKR1203AFSR-MJ SEKR1203AFTN-MJ SEKR1203AFPN-MS	SEKR1203AFTR-HS SEKR1203AFR-HS SEKR1203AFN-76 SEKR1203AFN-42
SEEN1203AFTN	E	Steel	SEE42TN-C9	SEEN1203AFTN1		SEEN42MT	SEEN1203AFTNCR-14	
SEKN1203AFTN	K		SEK42TN-C9	SEKN1203AFTN1 (SENN1203AFTN1)	SEKN1203AZ (SEMN1203AZ)	SEKN42MT (SENN1203AFTN)	SEKN1203AFTN SEKN1203AFTN-16 SEKN42AFTN SEKN42AFTN16	
SEKN1203AFFN	K	Cast Iron	SEK42FN-C9	(SEEN1203AFFN1)	SEKN1203AZ (SEMN1203AZ)	SEKN42M (SENN1203AFEN)	SEKN1203AFFN SEKN42AFFN	
SEEN1203AFFN	E	Non-ferrous Metals	SEE42FN-C9	(SECN1203AFFR1)				
SEKN1203EFTR	K	Steel	SEK42TR-G3	SEKN1203EFTR1	(SECN1203EER)		SEKN1203EFTR (SECN1203EFTR) (SEEN1203EFTR) (SECN42EFTRCR) (SEEN42EFTRCR)	
SEKN1504AFTN	K	Steel	SEK53TN-C9		SEKN1504AZ	SEKN53MT		SEKN1504AFTN
SPEN1203EESR	E	Cast Iron	(SPK42FR-A3E)	SPEN42EFSR1 SPEN1203EESR1 SPEN1203EEER1 (SPNN1203EEER1)				
SPMR1203EDER-H SPKR1203EDER-S	M K			(SPER1203EDER-JS)	SPKN1203EDR-WH		SPKR1203EDSR-MJ SPKR42SSR-MJ	SPKR1203EDR-76 SPKR1203EDTR-HS
SPCN1203EDTR	C	Steel		(SPEN1203EDR)	(SPAN1203EDR)	SPCH42TR-R	SPCN1203EDTR SPCN42STR	
SPKN1203EDTR	K		SPK42TR-A3	SPKN1203EDR	SPKN1203EDR	(SPCH42TR) (SPCH42TR-R)	SPKN1203EDTR SPKN42STR (SPEN1203EDTR) (SPEN42STR)	SPKN1203EDTR SPKN1203EDTR-42
SPKN1203EDFR	K	Cast Iron	SPK42FR-A3		SPKN1203EDR	(SPCH42R)	SPKN1203EDFR SPKN42SFR	SPKN1203EDFR
SPKN1504EDTR	K	Steel	SPK53TR-A3	SPKN1504EDR	SPKN1504EDR	(SPCH53TR-R)	SPKN1504EDTR SPKN53STR (SPCN1504EDTR) (SPCN53STR)	SPKN1504EDTR
SPKN1504EDFR	K	Cast Iron	SPK53FR-A3			(SPCH53R-R) (SPCH53TR-R)	SPKN1504EDFR SPKN53SFR	SPKN1504EDFR

Note 1. Tolerance class is different for description in ().

2. Since edge shape of Milling insert is slightly different by each maker, please adjust edges (Z axis direction) during operation.

Milling Insert Description Cross Reference Table

This table is Kyocera's own estimation based on publications and is not authorized by companies mentioned in it.

Kyocera	Class	Applications	Mitsubishi Hitachi Tool	Mitsubishi	Sandvik	Sumitomo	Tungaloy	Iscar
SPCN1203XPTR	C		SPC42TR-A5				SPCN1203ZPTR SPCN42ZTR	
SPKN1203XPTR	K	Steel	SPK42TR-A5				SPKN1203ZPTR SPKN42ZTR (SPEN1203ZPTR) (SPEN42ZTR)	
SPKN1203XPFR	K	Cast Iron	SPK42FR-A5				SPKN1203ZPFR SPKN42ZFR	
SPKN1504XETR	K	Steel		SPK53C2SR				
TPMR1603PDER-H	M			(TPER1603PPER-JS)	(TPKN1603PPR-WH)			(TPKR1603PPTR-HS)
TPKN1603PDTR	K	Steel	TPK32TR-E0 TPK32TR-G0	TPKN1603PPR (TPEN1603PPR)	TPKN1603PPR	TPKN32TR		TPKN1603PPTR
TPKN1603PDFR	K	Cast Iron	TPK32FR-E0		TPKN1603PPR	TPKN32R		TPKN1603PPFR
TPMR2204PDER-H TPKR2204PDER-S	M K			(TPER2204PDER-JS)	TPKN2204PDR-WH		TPMR2204PDSR-MJ TPKR2204PDSR-MJ TPKR43ZSR-MJ	TPKR2204PDTR-HS TPKR2204PD-R-76
TPKN2204PDTR	K	Steel	TPK43TR-E0 TPK43TR-G0	TPKN2204PDR (TPEN2204PDR)	TPKN2204PDR	(TPCH43TR)	TPKN2204PPTR TPKN43ZTR (TPCN2204PPTR) (TPCN43ZTR)	TPKN2204PDTR TPKN2204PDTR-42
TPKN2204PDFR	K	Cast Iron	TPK43FR-E0			(TPCH43R)	TPKN2204PPFR TPKN43ZFR (TPCN2204PPFR) (TPCN43ZFR) (TPEN2204PPTR-16) (TPEN43ZTR)	TPKN2204PDFR
TEMR1603PTER-H	M			(TEER1603PEER-JS)			(TEKR1603PEPR-MS)	
TEKN1603PTTR	K	Steel	TEK32TR-G0 (TEE32TR-G0)	(TEEN1603PETR1)		TEKN32TR	(TECN1603PETR) (TEEN1603PETR) (TECN32ZTR) (TEEN32ZTR)	
TEKN1603PTFR	K	Cast Iron	TEK32FR-G0 (TEE32FR-G0)	(TEEN1603PEFR1)		TEKN32R	(TEEN1603PEFR) (TEEN32ZFR)	
TEEN1603PTFR	E	Non-ferrous Metals		(TECN1603PEFR1)		TEEN32R	(TECN1603PEFR-D) (TECN32ZFR-DIA)	
TEMR2204PTER-H TEKR2204PTER-S	M K			(TEER2204PEER-JS)			TEKR2204PEPR-MS	
TEEN2204PTTR	E	Steel	TEE43TR-G0E (TEK43TR-G0E)	TEEN2204PETR1		TEEN43TR	TEEN2204PETR (TECN2204PETR) TEEN43ZTR (TECN43ZTR)	
TEKN2204PTTR	K		TEK43TR-G0E	TEKN2204PETR1		TEKN43TR	(TEEN2204PETR) (TECN2204PETR) (TEEN43ZTR) (TECN43ZTR)	
TEKN2204PTFR	K	Cast Iron	TEK43FR-G0E	(TEEN2204PEFR1)		TEKN43R	(TEEN2204PEFR) (TEEN43ZFR)	
		Non-ferrous Metals		(TECN2204PEFR1)		(TEEN43R)	(TECN2204PEFR-D) (TECN43ZFR-DIA)	
SNCN1204XNTN	C	Steel	SNC43TN-D5	SNC43B2S		(CSN43MT)	SNCN1204ZNTN SNCN43ZTN	
SNKN1204XNTN	K		SNK43TN-D5	SNK43B2S		(CSN43MT)	SNKN1204ZNTN SNKN43ZTN	
SNMF1204XNTN	M	Steel	(SNKF43TN-D5)	(SNKF43B2S)		(CSNB43MT)	(SNKF1204ZNTN) (SNKF43ZFN)	

Note 1. Tolerance class is different for description in ().

2. Since edge shape of Milling insert is slightly different by each maker, please adjust edges (Z axis direction) during operation.

Insert Grades
Indexable Inserts
Turning
CNC & CDD Tools
External
Small Parts
Machining
Boring
Grooving
Cut-off
Threading
Drilling
Solid Tools
Milling
Tools for Turning Mill
Spare Parts
Technical Information
Index

A
B
C
D
E
F
G
H
J
K
L
M
N
P
R
T

Terms and Angles of Toolholder

Terms and Angles of Turning Toolholder

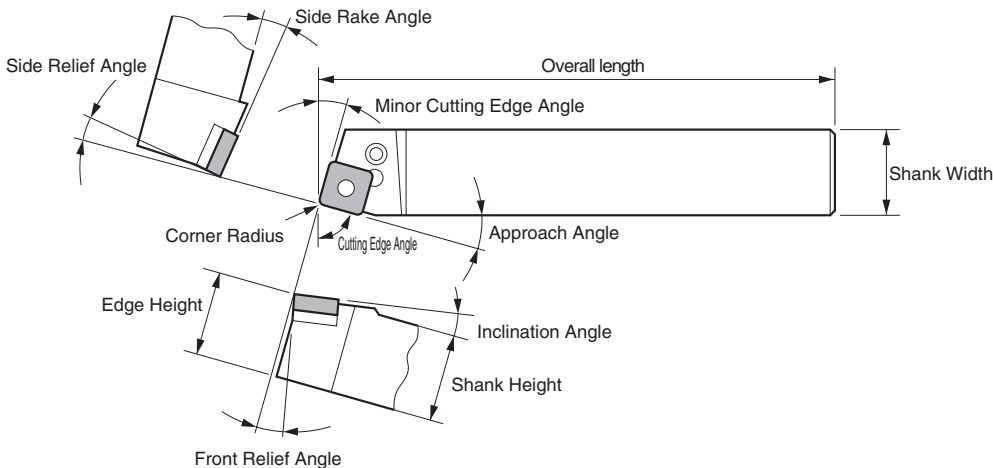

Function of Tool Angle

Tool Angle	Name	Function	Effect
Rake Angle	Side Rake Angle	· Affects cutting force, cutting heat, chip evacuation and tool life.	· If it is positive (+) angle, sharper cutting performance is obtained. (less cutting force, less edge strength) · Positive (+) angle is recommended for easy to machine workpieces or thin workpieces. · Smaller rake angle or negative (-) angle is recommended when a stronger edge is required like scale machining or interrupted machining.
	Inclination Angle		
Relief Angle	Front Relief Angle	· Prevents the tool's contact to the workpiece surface, except the cutting edge.	· When it is small, the cutting edge becomes strong, but the wear at relief faces may shorten the tool life.
	Side Relief Angle		
Cutting Edge Angle	Cutting Edge Angle	· Affects chip control and the direction of cutting force.	· When it is large, chip thickness becomes thick and chip control improves.
	Approach Angle	· Affects chip control and the direction of cutting force.	· When it is large, chip thickness becomes thin and chip control worsens, but cutting force is dispersed and edge strength improves. · When it is small, chip control ability improves.
	Minor Cutting Edge Angle	· Prevents friction between cutting edge and workpiece surface.	· When it is large, edge strength deteriorates.

Toolholder Rigidity

1. Flexure of Toolholder

$$\delta = \frac{4 \times F \times (LPR)^3}{E \times B \times H^3} = \frac{4 \times k \times ap \times f \times (LPR)^3}{E \times B \times H^3}$$

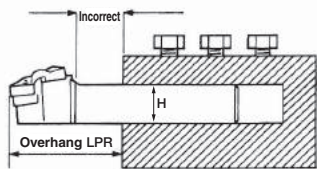

Symbol	Name	Unit
δ (Delta)	Deflection	mm
B	Shank Width	mm
H	Shank Height	mm
E	Young ratio	N/mm ²
ap	Depth of Cut	mm
f	Feed Rate	mm/rev
k	Specific Cutting Force	N/mm ²
LPR	Overhang	mm
F	Cutting force	N

$$(F = k \times ap \times f)$$

The flexural strength of toolholder will decrease by increasing of shank height by third root and will decrease of reducing overhang by third root. Minimizing toolholder shank overhang as much as possible is important as well as shank's sectional square measure.

2. Flexure of Boring Bar

$$\delta = \frac{64 \times F \times (LPR)^3}{3 \times E \times \pi \times (DCON)^3} = \frac{64 \times k \times ap \times f \times (LPR)^3}{3 \times E \times \pi \times (DCON)^3}$$

Symbol	Name	Unit
δ (Delta)	Deflection	mm
DCON	Shank Dia.	mm
E	Young ratio	N/mm ²
ap	Depth of Cut	mm
f	Feed Rate	mm/rev
k	Specific Cutting Force	N/mm ²
LPR	Overhang	mm
F	Cutting force	N

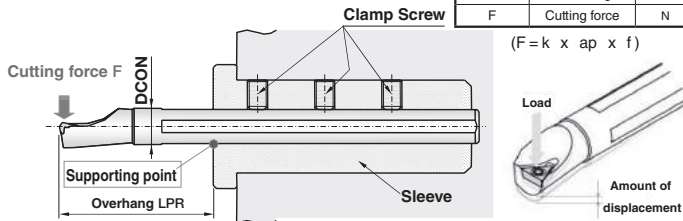

$$(F = k \times ap \times f)$$

Terms and Angles of Milling Cutter

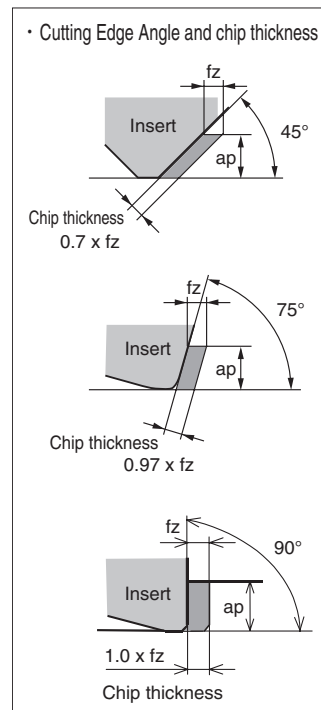
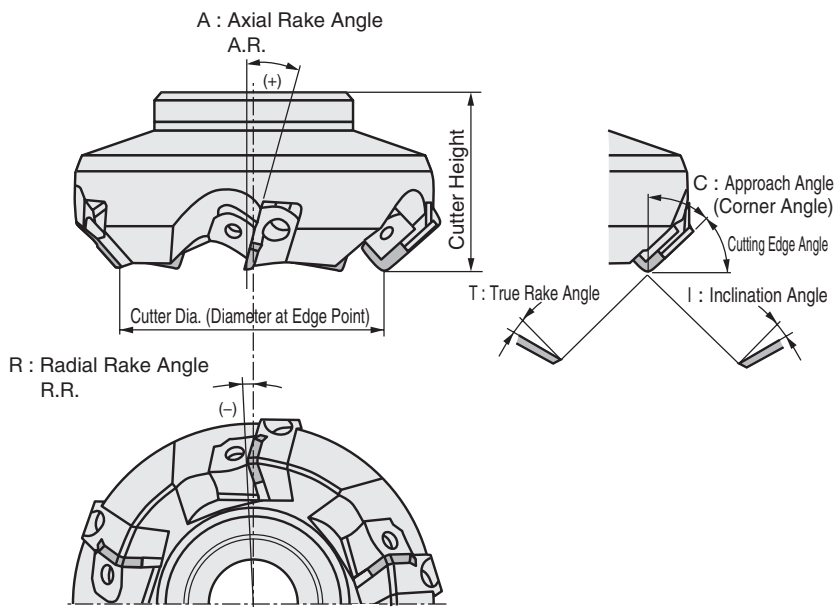

Function of Tool Angle

Symbol	Name	Function	Effect
A	Axial Rake Angle (A.R.)	Controls chip flow direction and cutting force	When it is positive ... Good cutting performance and less chip welding
R	Radial Rake Angle (R.R.)	Controls chip flow direction and cutting force	When it is negative ... Good chip evacuation
C	Approach Angle	Controls chip thickness and chip flow direction	When it is large ... Thinner chip thickness Lower cutting load
T	True Rake Angle	Actual rake angle	When it is positive ... Good cutting performance and less chip welding, but lower edge strength When it is negative ... Higher edge strength but easier to weld
I	Inclination Angle	Controls chip flow direction	When it is positive ... Good chip evacuation Less cutting force Lower edge stability of the corner part

The Formula for True Rake Angle : $\tan T = \tan R \times \cos C + \tan A \times \sin C$

The Formula for Inclination Angle : $\tan I = \tan A \times \cos C - \tan R \times \sin C$

No. of Inserts (Z)

1) If the number of stages is one

If the number of stages is one, it is not indicated on the catalogue.
Please use "No. of inserts" of the catalogue for "Z" of the formula to calculate cutting conditions.

MECX End Mill

Description	Stock	No. of Inserts	DC
MECX 08-S10-07-1T	●	8	8
14-S12-07-2T	●	2	14

$fz = \frac{Vf}{Z \times n}$ → $Vf = fz \times Z \times n$

2) If the number of stages is more than two

If the number of stages is more than two, it is indicated on the catalogue.
Please use "No. of flutes" of the catalogue for "Z" of the formula to calculate cutting conditions.

MSR

Description	Stock	No. of Inserts	No. of Flutes	No. of Stages	DC	DCSMS
MSR 063R-1	●	4	1	1	63	50
063R-2	●	8	4	2	63	50

$fz = \frac{Vf}{Z \times n}$ → $Vf = fz \times Z \times n$

Solid End Mill

Terms of Solid End Mill

● Square

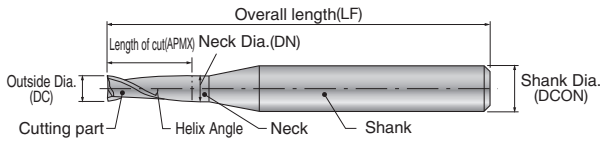

● Radius

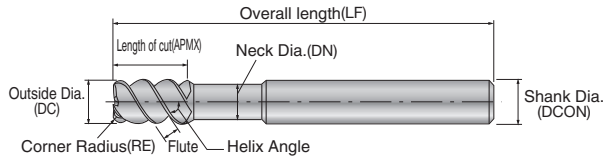

● Ball-nose

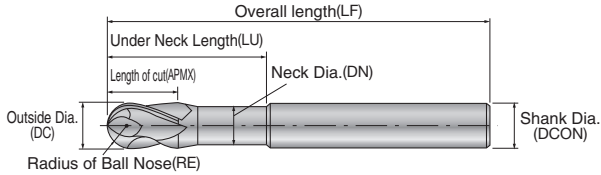

● Cutting edge shape

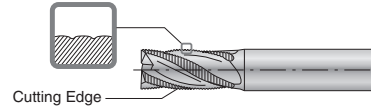

● Cutting Edge Profile

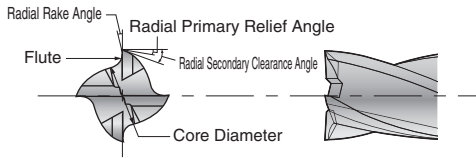

* The illustration shows squared 4 flutes tool

● Core diameter rate(%)=Core Diameter ÷ Outside Dia. x 100

● Cutting Edge With Corner Land

Advanced Fracture Resistance with Corner Land

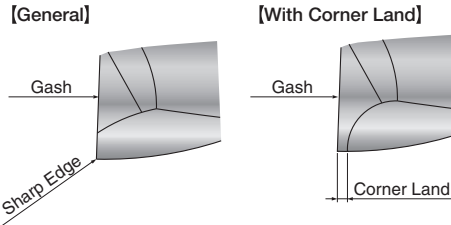

Trouble shooting of Solid End Mill

Trouble	Trouble Item	Check Item	Cutting Conditions							Tool Geometry				Setting		Machine			
			Vc	fz	ap	Cutting Direction	Low Pick Feed	Compressed Air	Coolant			Helix Angle	No. of Blades	Diameter	Large Chip Pocket		Workpiece / Tool Installation	Shorten Tool Overhang	
		Countermeasures	Higher (Larger) ↑ Lower (Smaller) ↓																
Edge Damage	Cutting Edge Wear	Unsuitable Cutting Conditions	● ↓								●								
		Less Number of Blades																	
		Up Cut																	
	Chipping of Cutting Edge	Unsuitable Cutting Conditions		● ↓	● ↓														
		Lack of Cutting Edge Strength												●					
		Insufficient Clamping Force															●	●	●
Fracture Occurs	Unsuitable Cutting Conditions			● ↓															
	Lack of Tool Rigidity												● ↑	●					
	Chip Packing										●			●					
Cutting Accuracy	Poor Finished Surface on Walls	Unsuitable Cutting Conditions	● ↓		● ↓														
		Chip Jamming							●	●	●								
		Cutting edge wear	● ↓																
	Poor Finished Surface on Faces	Large Pick Feed								●									
		Unsuitable Cutting Conditions		● ↓	● ↓														
		Lack of Tool Rigidity												● ↑	● ↑	● ↑	●		
Out of Vertical	Cutting Edge Wear	● ↓																	
	Unsuitable Cutting Conditions	● ↓	● ↓	● ↓															
	Insufficient Clamping Force															●	●	●	
Others	Heavy Chattering, Vibration	Unsuitable Cutting Conditions	● ↓	● ↓															
		Lack of Tool Rigidity												● ↑	● ↑	● ↑	●		
		Insufficient Clamping Force															●	●	●
Chip Jamming	Unsuitable Cutting Conditions		● ↓	● ↓															
	Improper tool geometry													● ↓		●			

R
Technical Information

Solid Drill

Terms of Solid Drill

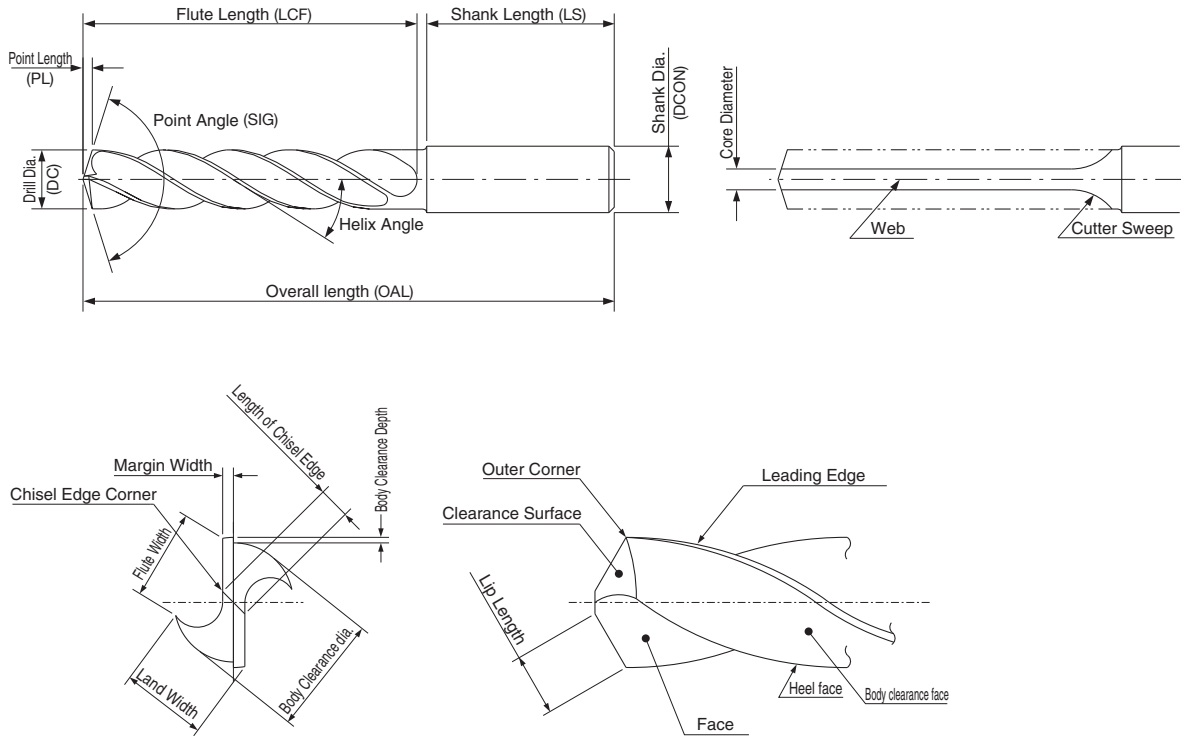

Trouble shooting of Solid Drill

Trouble	Check Item	Cutting Conditions				Tool Geometry				Setting			Machine					
		Vc	fz	Initial Cutting	Breaking Through	Step Feed	Coolant		Chisel Width	Honing Width	Core Diameter	Flute Length		Coolant Type	Accuracy	Face	Overhang	
	Countermeasures	Higher (Larger)↑ Lower (Smaller)↓		Lower Feed at Initial Cutting	Lower Feed when Breaking Through	Step Feed	Increase Volume	Increase Pressure	Larger ↑ Smaller ↓	Smaller ↓	Shorten	Use Internal Coolant	Improve Tool Installation Accuracy	Flat Workpiece Face	Shorten Tool Overhang	Power, Rigidity		
Edge Damage	Fracture Occurs	Unsuitable Cutting Conditions	● ↓															
		Poor Rigidity of Drill								● ↑	●				●			
	Large Peripheral Cutting Edge and Margin Land Wear	Unsuitable Cutting Conditions	● ↓															
		High Cutting Heat at the Cutting Edge Point						●					●					
	Chipping on Peripheral Cutting Edge	Poor Run-out Accuracy												●				
		Unsuitable Cutting Conditions		● ↓		●												
Chipping on Chisel	Large Deflection of Tool Holder													●			●	
	Chattering Occurs (Vibration)													●			●	
	Too Wide Chisel Width								● ↓									
Cutting Accuracy	Enlarge Hole Diameter	Poor Entry			●													
		Chattering Occurs (Vibration)								● ↓								●
	Reduce Hole Diameter	Unsuitable Cutting Conditions	● ↑															
		Poor Rigidity of Drill	● ↓								● ↑	●						
	Poor Straightness	High Cutting Heat at Cutting Edge Point						●					●					
		Poor Rigidity of Drill									● ↑	●						●
Poor Hole Position Accuracy, Roundness, Straightness, Surface Roughness	Large Deflection of Tool Holder												●					
	Unsuitable Cutting Conditions			●														
	Poor Rigidity of Drill									● ↑	●						●	
Burr	Large Burrs at Hole Exit	Large Deflection of Tool Holder																
		Insufficient Clamping Force																
Chip Control	Long Chips	Unsuitable Cutting Conditions																
		Poor Chip Disposal		● ↑														
	Chip Packing	Unsuitable Cutting Conditions	● ↓	● ↓														
Poor Chip Disposal							●	●					●					

Insert Grades A
 Turning B
 Indexable Inserts C
 CNC & PCD Tools D
 External E
 Small Parts F
 Machining G
 Boring H
 Grooving I
 Cut-off J
 Threading K
 Drilling L
 Solid Tools M
 Milling N
 Tools for Spare Parts O
 Technical Information P
 Index Q

Precautions when using WF / WE Chipbreaker (Negative Insert)

WF / WE Chipbreaker Edge Position Offset Adjustment

For D type and T type, cutting edge offsets are required.

Cutting Edge Offsets (mm)					
DNMX150404WF		DNMX150408WF		DNMX150412WF	
DNMX150604WF		DNMX150608WF		DNMX150612WF	
X-direction	Z-direction	X-direction	Z-direction	X-direction	Z-direction
0.24	0.02	0.14	0.01	0.11	0.01

Cutting Edge Offsets (mm)					
TNMX160404WF		TNMX160408WF		TNMX160412WF	
X-direction	Z-direction	X-direction	Z-direction	X-direction	Z-direction
0.24	0.01	0.16	0.00	0.11	0.00

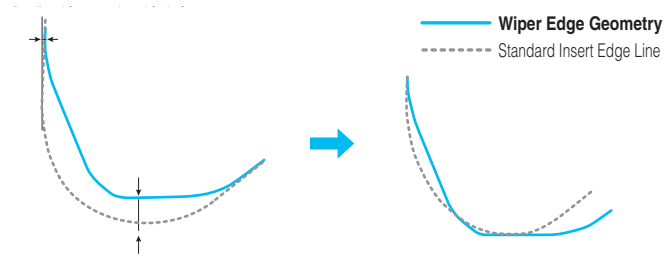

For D type and T type inserts, program corrections are required for ramping and up facing.

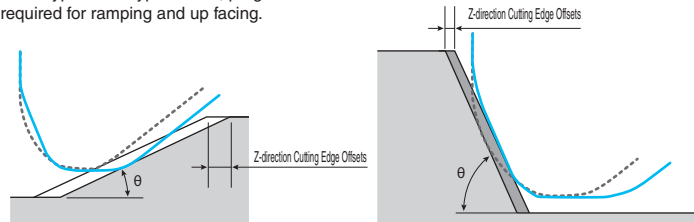

DNMX1504 type DNMX1506 type	Corner-R(RE) (mm)	Ramping Angle θ					
		0°	5°	10°	15°	20°	25°
Z-direction Cutting Edge Offsets (mm)	0.4	0.00	-0.34	-0.35	-0.36	-0.36	-0.36
	0.8	0.00	-0.26	-0.26	-0.25	-0.24	-0.22
	1.2	0.00	-0.15	-0.17	-0.16	-0.15	-0.15

Z-direction Cutting Edge Offsets (mm)	Corner-R(RE) (mm)	Up Facing Angle θ																		
		0°	5°	10°	15°	20°	25°	30°	35°	40°	45°	50°	55°	60°	65°	70°	75°	80°	85°	90°
0.4	0.00	-0.02	-0.03	-0.03	-0.04	-0.05	-0.06	-0.07	-0.08	-0.09	-0.10	-0.11	-0.12	-0.10	-0.08	-0.06	-0.04	-0.02	0.00	
	0.8	0.00	0.13	0.12	0.11	0.09	0.07	0.05	0.04	0.02	0.00	-0.02	-0.05	-0.07	-0.06	-0.04	-0.02	-0.01	-0.01	0.00
	1.2	0.00	0.36	0.34	0.31	0.27	0.24	0.20	0.16	0.13	0.09	0.05	0.00	-0.04	-0.04	-0.03	-0.02	-0.01	-0.01	0.00

TNMX1604 type	Corner-R(RE) (mm)	Ramping Angle θ					
		0°	5°	10°	15°	20°	25°
Z-direction Cutting Edge Offsets (mm)	0.4	0.00					
	0.8	0.00					
	1.2	0.00					

Do not use TNMX1604 type insert for ramping.

Z-direction Cutting Edge Offsets (mm)	Corner-R(RE) (mm)	Up Facing Angle θ																		
		0°	5°	10°	15°	20°	25°	30°	35°	40°	45°	50°	55°	60°	65°	70°	75°	80°	85°	90°
0.4	0.00	-0.06	-0.05	-0.05	-0.06	-0.07	-0.08	-0.08	-0.09	-0.10	-0.11	-0.12	-0.13	-0.12	-0.10	-0.07	-0.05	-0.02	0.00	
	0.8	0.00	0.11	0.11	0.10	0.08	0.06	0.04	0.02	0.00	-0.02	-0.04	-0.06	-0.08	-0.08	-0.06	-0.04	-0.02	-0.01	0.00
	1.2	0.00	0.34	0.32	0.29	0.25	0.22	0.19	0.15	0.14	0.08	0.04	0.00	-0.05	-0.05	-0.03	-0.01	0.00	0.00	0.00

Caution (Finished Edge Line)

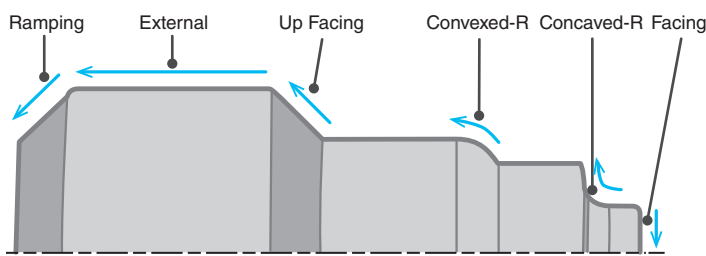

Applications	Notes
External / Facing	Toolholders for D type and T type cannot provide sufficient performance.
Up Facing Ramping	For D type and T type inserts, program corrections on Z direction are required.
Convexed-R / Concaved-R	Do not use wiper insert if a precise R shape is needed.

Convexed-R and Concaved-R Machining [Difference from standard insert]

Unmachined part and cut-away occur on the connection between the circular and the straight line.

There is a limit to the use of a wiper insert when there is an R parameter symbol. Please refer to the guideline of finished dimension

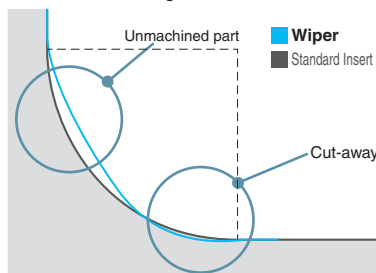

D type		Unit : mm
Nominal Corner-R	Guideline of Finished Dimension	
0.4	R0.4 $\begin{smallmatrix} +0.4 \\ 0 \end{smallmatrix}$	
0.8	R0.8 ± 0.2	
1.2	R1.2 $\begin{smallmatrix} +0.3 \\ -0.4 \end{smallmatrix}$	

T type		Unit : mm
Nominal Corner-R	Guideline of Finished Dimension	
0.4	R0.4 $\begin{smallmatrix} +0.4 \\ 0 \end{smallmatrix}$	
0.8	R0.8 ± 0.2	
1.2	R1.2 $\begin{smallmatrix} +0 \\ -0.4 \end{smallmatrix}$	

Precautions when using WP Chipbreaker (Positive Insert)

WP Chipbreaker (Positive Insert) Edge Position Offset Adjustment Neutral Insert

For D type and T type, cutting edge offsets are required.

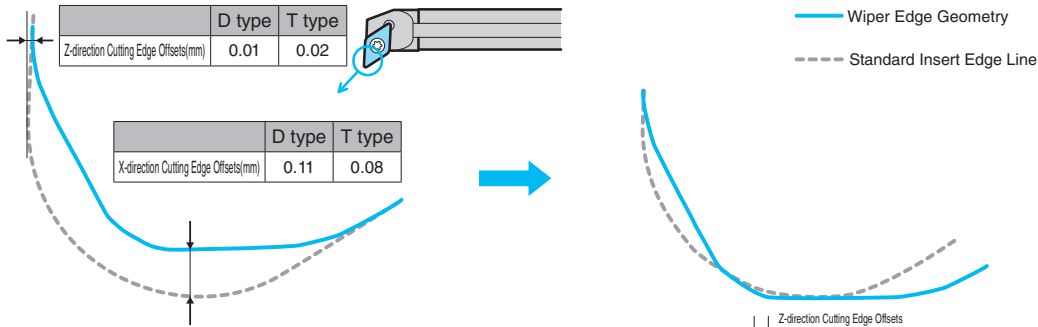

For D type and T type inserts, program corrections are required for ramping and up facing.

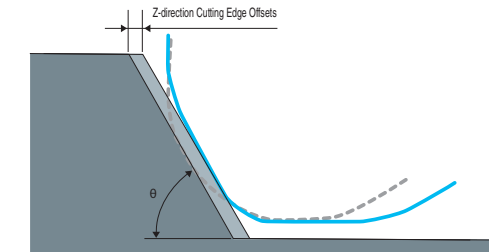
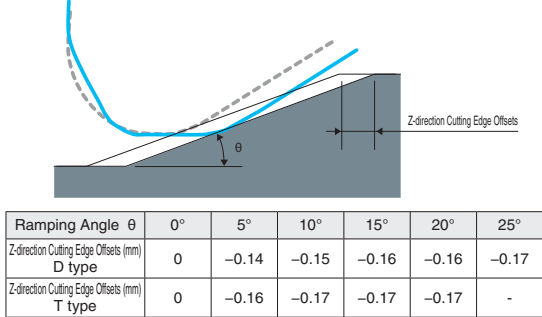

Profiling Angle θ	40°	45°	50°	55°	60°	65°	70°	75°	80°	85°	90°
Z-direction Cutting Edge Offsets (mm) D type	-0.01	-0.02	-0.03	-0.04	-0.05	-0.05	-0.04	-0.03	-0.02	-0.01	0.00
Z-direction Cutting Edge Offsets (mm) T type	-	-	-	-0.01	-0.02	-0.03	-0.04	-0.03	-0.02	-0.01	0.00

Handed Insert

For D type and T type, cutting edge offsets are required.

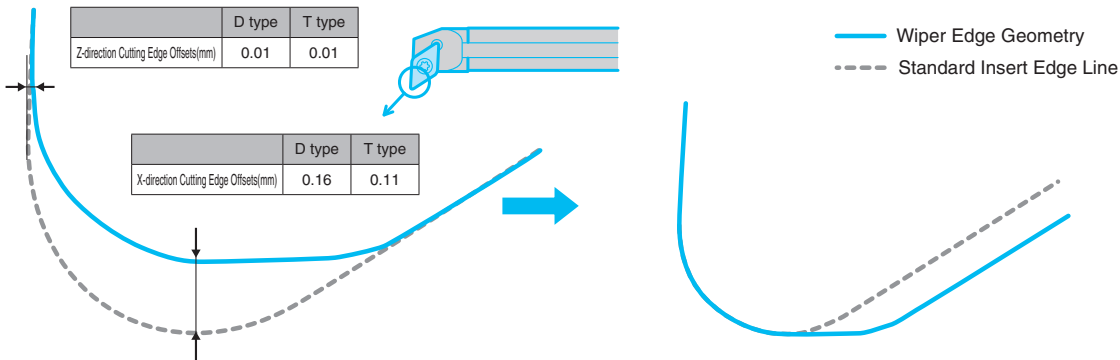



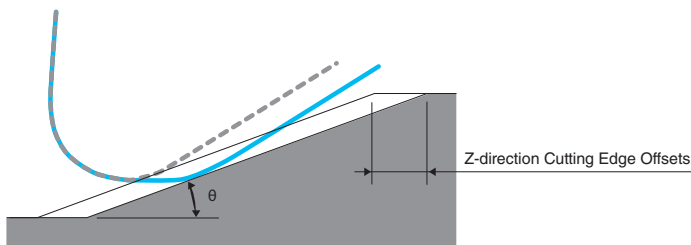







For D type and T type inserts, program corrections are required for ramping.

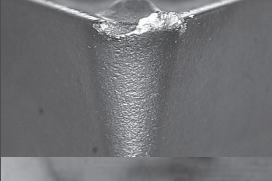

Ramping Angle θ	0°	5°	10°	15°	20°	25°
Z-direction Cutting Edge Offsets (mm) D type	0	-0.22	-0.24	-0.24	-0.25	-0.25
Z-direction Cutting Edge Offsets (mm) T type	0	-0.24	-0.24	-0.25	-0.24	-

Insert Grades	A
Turning	B
Indexable Inserts	C
CBN & PCBN Tools	D
External	E
Small Parts Machining	F
Boring	G
Grooving	H
Cut-off	J
Threading	K
Drilling	L
Solid Tools	M
Milling	N
Tools for Turning Mill	P
Spare Parts	R
Technical Information	T

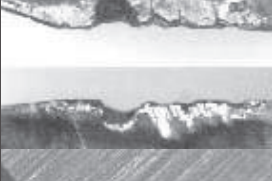
Cutting Edges Figuration and Countermeasures

Typical Cutting Edge Figuration	Observation	Causes	Countermeasures
Nose wear 	<ul style="list-style-type: none"> · Deterioration of surface roughness and dimensional accuracy 	<ul style="list-style-type: none"> · Too high Vc · End of tool life 	<ul style="list-style-type: none"> · Reduce Vc · Change to higher wear resistant grade
Notching 	<ul style="list-style-type: none"> · Burr formation · Cutting force increase 	<ul style="list-style-type: none"> · Too high f and Vc 	<ul style="list-style-type: none"> · Sharper cutting performance · Reduce Vc · Change to higher heat resistant grade
Crater wear 	<ul style="list-style-type: none"> · Chip control deterioration · Surface finish deterioration (peeled surface) 	<ul style="list-style-type: none"> · Too high Vc 	<ul style="list-style-type: none"> · Reduce Vc · Change to high speed type like Cermet or Al₂O₃ coated insert grade
Plastic Deformation 	<ul style="list-style-type: none"> · Workpiece dimension changes · Crack at nose 	<ul style="list-style-type: none"> · Too high cutting load · Inappropriate insert grade 	<ul style="list-style-type: none"> · Change to harder grade · Reduce f and ap
Crack from Wear 	<ul style="list-style-type: none"> · Surface finish's sudden deterioration · Workpiece dimension changes 	<ul style="list-style-type: none"> · Too high Vc 	<ul style="list-style-type: none"> · Change the tool earlier · Change to higher wear resistant grade
Chipping 	<ul style="list-style-type: none"> · Cutting force increase · Surface roughness deterioration 	<ul style="list-style-type: none"> · Too high f · Chattering · Lack of insert toughness 	<ul style="list-style-type: none"> · Reduce f and ap · Change to more rigid toolholder · Change to tougher grade
Crack from Welding or Built-up Edge 	<ul style="list-style-type: none"> · Surface finish deterioration · Cutting force increase 	<ul style="list-style-type: none"> · Too low Vc 	<ul style="list-style-type: none"> · Increase Vc · Improve sharp cutting performance (rake angle, chamfer)
Mechanical Fracture 	<ul style="list-style-type: none"> · Sudden cracking · Unstable tool life 	<ul style="list-style-type: none"> · Too high f and ap · Chattering 	<ul style="list-style-type: none"> · Change to tougher grade · Enlarge chamfer · Enlarge Corner-R(RE) · Change to more rigid toolholder
Fracture from Thermal Crack 	<ul style="list-style-type: none"> · Cracking by heat cycle · Possible in interrupted machining and milling 	<ul style="list-style-type: none"> · Too high Vc and f 	<ul style="list-style-type: none"> · Reduce f · Reduce Vc · Change to dry cutting
Flaking 	<ul style="list-style-type: none"> · Possible in hard materials machining · Possible in machining with chattering 	<ul style="list-style-type: none"> · Lack of insert toughness · Poor rigidity of toolholder 	<ul style="list-style-type: none"> · Change to tougher grade (TiC-base ceramic to CBN.) · Change to more rigid toolholder · Change edge preparation

Turning

Trouble	Check Item	Countermeasures	Insert Grades				Cutting Conditions				Tool Geometry					Setting		Machine					
			Change to Harder Grade	Change to Tougher Grade	Change to More Thermal Shock Resistant Grade	Change to More Welding Resistant Grade	Vc	f	ap	Tool Path Review	Coolant		Chipbreaker Review	Rake Angle	Corner-R(R/RE)	Approach Angle	Edge Strength / Honing	Change to Higher Tolerance (M→G)	Toolholder Rigidity	Workpiece / Tool Installation	Overhang Length	Power, Rigidity	
Unstable Dimension	Unstable Workpiece Dimension	Unsuitable Insert Tolerance															●						
		Tool and Workpiece Evacuation											●	●↑	●↓	●↓			●	●	●	●	
	Frequent Offset during Machining	Flank Wear Increase	●												●↑								
		Unsuitable Cutting Conditions					●↓	●↑															
		Built-up Edge				●	●↑																
	Surface roughness deterioration	Poor Surface Roughness	Poor Cutting by Tool Wear	●			●	●↓				●		●	●↑	●↑	●↓	●					
Chipping				●			●↓	●↓				●		●↑	●↑	●↑	●			●	●	●	
Welding, Built-up Edge						●	●↑				●		●	●↑		●↓	●						
Unsuitable Cutting Conditions							●↑	●↓	●↓		●												
Unsuitable Tool Geometry													●		●↑	●↓	●						
Vibration, Chattering				●			●↓	●↑	●↓				●	●↑	●↓	●↓	●↓		●	●	●	●	●
Heat	Deterioration of Accuracy or Tool Life by Cutting Heat	Unsuitable Cutting Conditions					●↓	●↓	●↓		●												
		Unsuitable Insert Grades and Tool Geometry	●										●	●↑		●↓							
Burr, Workpiece Chip Off and Scuffing	Burr	Unsuitable Cutting Conditions					●↓	●↑		●	●												
		Unsuitable Insert Grades and Tool Geometry	●										●	●↑	●↓	●↓	●↓						
	Workpiece Chip Off	Unsuitable Cutting Conditions					●↓	●↓	●														
		Unsuitable Insert Grades and Tool Geometry	●										●	●↑	●↑	●↑	●↓		●	●	●	●	
	Scuffing	Unsuitable Cutting Conditions					●↑	●↓			●												
		Unsuitable Insert Grades and Tool Geometry	●			●							●	●↑		●↓							
Edge Damage	Wear Increase at Relief Face, Rake Face	Flank Wear	●				●↓				●		●	●↑	●↑	●↓							
		Rake Face Wear	●				●↓	●↓	●↓		●		●	●↑	●↑								
	Notching	Notching				●	●↓				●												
	Chipping	Vibration, Chattering	●				●↓	●↓				●			●↑	●↑		●	●	●	●	●	
	Crack	Unsuitable Insert Grades and Cutting Conditions	●	●			●↓	●↓				●		●↑	●↑	●↑		●	●	●	●	●	
	Thermal Crack	Work Hardness, Unsuitable Insert Grades and Cutting Conditions			●		●↓	●↓	●↓		●		●	●↑		●↓							
	Edge Nose Deformation	Edge Nose Deformation during Interrupted machining	●				●↓	●↓	●↓			●	●↓	●↑	●↑	●↑							
	Built-up Edge	Work Hardness, Unsuitable Insert Grades and Cutting Conditions				●	●↑	●↑			●		●	●↑		●↓	●						
Chip Control	Long, Tangling Chips	Unsuitable Cutting Conditions					●↑	●↑	●↑	●		●											
		Unsuitable Tool Geometry										●		●↓	●↓								
	Chips scattering	Unsuitable Cutting Conditions					●↓	●↓			●												
		Unsuitable Tool Geometry										●		●↑	●↑								

*1) To prevent chattering, the higher f may be suitable.

*2) To prevent scuffing, the higher f may be suitable.

*3) When using X chipbreaker insert for soft steel and low carbon steel, the higher Vc cuts chips short.

Insert Grades
Turning
Indexable Inserts
CN & PCD Tools
External
Small Parts
Machining
Boring
Grooving
Cut-off
Threading
Drilling
Solid Tools
Milling
Turning Mill
Spare Parts
Technical Information
Index

A
B
C
D
E
F
G
H
J
K
L
M
N
P
R
T

Trouble shooting

Milling

Trouble	Countermeasures	Check Item	Insert Grades				Cutting Conditions					Tool Geometry						Setting		Machine							
			Change to Harder Grade	Change to Tougher Grade	Change to More Thermal Shock Resistant Grade	Change to More Welding Resistant Grade	Vc	fz	ap	Cutter Dia. Cutting Width Review	Tool Path Review	Coolant		Insert with Chipbreaker	Relief Angle	Corner Angle	Edge Strength / Honing	No. of Inserts	Chip pocket		Wiper Edge (Relief Angle) Review	Insert Runout Check	Cutter Rigidity	Workpiece / Tool Installation	Overhang Length	Power, Rigidity	
												Usage of Mist	Dry														Larger ↑ Smaller ↓
Edge Damage	Flank Wear Increase	Unsuitable Cutting Conditions					● ↓					●															
		Unsuitable Tool Geometry	●											● ↑		● ↓			●								
	Rake Face Wear Increase	Unsuitable Cutting Conditions					● ↓	● ↓	● ↓			●															
		Unsuitable Tool Geometry	●											● ↑	● ↑	● ↓											
	Chipping, Cracking	Unsuitable Cutting Conditions					● ↓	● ↓	●	●																	
		Unsuitable Tool Geometry		●										● ↓	● ↑	● ↑			●	●	●	●	●	●	●	●	●
	Edge Breakage by Thermal Shock	Unsuitable Cutting Conditions					● ↓	● ↓	● ↓				●														
		Unsuitable Tool Geometry			●										● ↑		● ↓										
Built-up Edge	Unsuitable Cutting Conditions					● ↑	● ↑					●															
	Unsuitable Tool Geometry				●									● ↑		● ↓											
Cutting Accuracy	Poor Surface Finish	Unsuitable Cutting Conditions					● ↑	● ↓	● ↓			●															
		Unsuitable Tool Geometry	●		●											● ↓	● ↓		●	●		●	●	●	●	●	
	Burr formation	Unsuitable Cutting Conditions					● ↓	● ↓	● ↓	●	●																
		Unsuitable Tool Geometry												● ↑	● ↓	● ↓			●								
	Workpiece Chip Off	Unsuitable Cutting Conditions					● ↓	● ↓			●																
		Unsuitable Tool Geometry												● ↑	● ↑	● ↓	● ↑		●								
Poor Planeness / Parallelism	Tool and Workpiece Evacuation					● ↓	● ↓				● ^{*5}		●	● ↑	● ↓	● ↓	● ↓	●	●	●	●	●	●	●	●		
Others	Heavy Chattering, Vibration	Unsuitable Cutting Conditions, Installation					● ↓	● ^{*1} ↓	● ^{*2} ↓	●	● ^{*4}			●	● ↑	● ↓	● ↓	● ↓				●	●	●	●	●	
		Unsuitable Cutting Conditions					● ↑	● ^{*3} ↓		●		● ^{*6}	●		●	● ↑											
	Chip Jamming	Unsuitable Tool Geometry											●	● ↑		● ↓	● ↑										

- *1) To prevent chattering, the higher fz may be suitable.
- *2) To prevent chattering, the larger ap may be suitable.
- *3) Higher fz may be suitable.
- *4) Down-cut method is recommended for helical end milling.
- *5) If the surface is warped by cutting heat.
- *6) Compressed air is recommended.

Drilling (Magic Drill Series)

Trouble	Countermeasures	Check Item	Insert Grades		Cutting Conditions			Tool Geometry			Setting			Machine	
			Change to Harder Grade	Change to Tougher Grade	Vc	fz	Coolant Discharge Condition	Chipbreaker Review	Inner Edge's Center Height Check (Core Dia. Check)	Toolholder Rigidity Improvement (Short Type)	Workpiece / Tool Installation	Insert Installation	Offset Check	Adjustable Sleeve Usage	Power, Rigidity
					Higher (Larger)↑ Lower (Smaller)↓										
Edge Damage	Unusual Wear	Unsuitable Cutting Speed (too high)	●		● ↓										
		Unsuitable Cutting Speed (too low)		●	● ↑										
		Unsuitable Coolant Discharge					●								
		Poor Rigidity of Machine / Workpiece								●				●	
		Small Hole Dia.										↑	●		
		Unsuitable Insert Grade	●										●		
	Inner Edge Cracking	No core, Too Small Core							● ↑						
		Poor Rigidity of Machine / Workpiece								●	●				●
		Unstable Drilling Start					● ↓								
		High Hardness Workpiece	●		● ↓	● ↓									
		Clogged Chips			● ↑				● ↓						
		Unstable Insert Installation									●				
	Outer Edge Cracking	Poor Rigidity of Machine / Workpiece									●				●
		Unstable Drilling Start					● ↓								
		High Hardness Workpiece	●		● ↓	● ↓									
Poor Chip Control			●	● ↑											
Unstable Insert Installation										●					
Toolholder, Others	Scratches on Tool Body	Poor Rigidity of Machine / Workpiece								●				●	
		Inaccurate Tool Installment										↑	●		
		Clogged Chips			● ↑	● ↓									
		Unstable Drilling Start				● ↓									
	Poor Hole Dia. Accuracy / Surface Finish	Poor Rigidity of Machine / Workpiece									●				●
		Poor Rigidity of Toolholder								●		●			
		Inaccurate Tool Installment										↑	●		
		Clogged Chips			● ↑	● ↓		● ↓							
		Large Core Dia.						● ↓							
		Unstable Drilling Start				● ↓									
		Unsuitable Coolant Discharge					●								
	Large Vibration / Chattering	Unsuitable Cutting Conditions, Installation			● ↑	● ↓				●	●			●	
	Long Chips	Unsuitable Cutting Conditions			● ↑										
		Unsuitable Chipbreaker						●							
	Machine Failure	Lack of Machine Power			● ↓	● ↓		●						●	

*1) For lathe operation

Insert Grades
Turning
Indexable Inserts
CN & PCD Tools
External
Small Parts
Boring
Grooving
Cut-off
Threading
Drilling
Solid Tools
Milling
Tools for Turning Mill
Spare Parts
Technical Information
Index

A
B
C
D
E
F
G
H
J
K
L
M
N
P
R
T

Basic Formulas

Turning

Cutting speed

$$V_c = \frac{\pi \times D_m \times n}{1,000}$$

V_c : Cutting speed [m/min]

D_m : Workpiece Dia. [mm]

n : Spindle Revolution [min^{-1}]

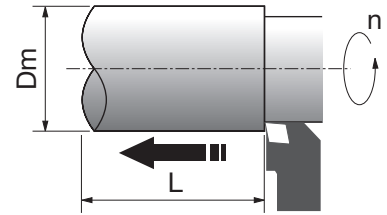

Power Requirement

$$P_c = \frac{K_s \times V_c \times a_p \times f}{6,120 \times \eta}$$

P_c : Power Requirement [kW]

P_{HP} : Power Requirement (Horse Power) [HP]

V_c : Cutting speed [m/min]

a_p : Depth of Cut [mm]

f : Feed Rate [mm/rev]

K_s : Specific Cutting Force [kgf/mm²]

η : Mechanical Efficiency (0.7 ~ 0.8)

Ks [kgf/mm ²]	
Low Carbon Steel	190
Medium Carbon Steel	210
High Carbon Steel	240
Low Alloy Steel	190
High Alloy Steel	245
Cast Iron	93
Malleable Cast Iron	120
Bronze, Brass	70

Theoretical Surface Roughness

$$R_z(h) = \frac{f^2}{8 \times R(RE)} \times 1,000$$

$R_z(h)$: Theoretical Surface Roughness [μm]

f : Feed Rate [mm/rev]

$R(RE)$: Corner Radius of Insert [mm]

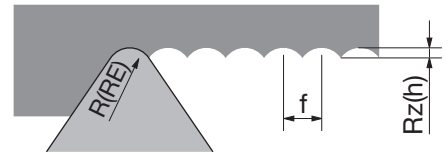

Chip Removal Volume

$$Q = V_c \times a_p \times f$$

Q : Chip Removal Volume [$\text{cm}^3/\text{min}=\text{cc}/\text{min}$]

V_c : Cutting speed [m/min]

a_p : Depth of Cut [mm]

f : Feed Rate [mm/rev]

Edge Position Compensation when Changing Corner-R(RE)

$$\Delta X = (R - R') \times \left\{ \frac{\cos\left(\frac{\text{EPSR}}{2} + (\text{KRINS} - 90^\circ)\right)}{\sin\frac{\text{EPSR}}{2}} - 1 \right\}$$

$$\Delta Z = (R - R') \times \left\{ \frac{\sin\left(\frac{\text{EPSR}}{2} + (\text{KRINS} - 90^\circ)\right)}{\sin\frac{\text{EPSR}}{2}} - 1 \right\}$$

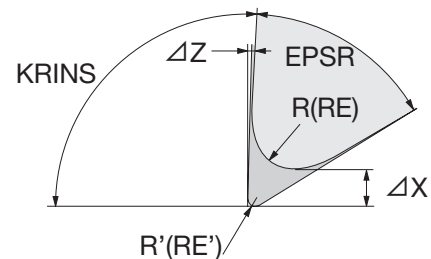

ΔX : X-direction Cutting Edge Offsets [mm]

ΔZ : Z-direction Cutting Edge Offsets [mm]

R : Corner-R before Change [mm]

R' : Corner-R after Change [mm]

EPSR : Insert Corner Angle [°]

KRINS : Toolholder's Cutting Edge Angle [°]

Toolholder Type	Insert Corner Angle EPSR	Cutting Edge Angle KRINS	ΔX	ΔZ
DCLN/PCLN	80°	95°	0.100 x (R-R')	0.100 x (R-R')
DTGN/PTGN	60°	91°	0.714 x (R-R')	0.030 x (R-R')
DDJN/PDJN	55°	93°	0.866 x (R-R')	0.099 x (R-R')
DDHN/PDHN	55°	107.5°	0.531 x (R-R')	0.531 x (R-R')
DVLN/PVLN	35°	95°	2.072 x (R-R')	0.273 x (R-R')
DVPN/PVPN	35°	117.5°	1.351 x (R-R')	1.351 x (R-R')
DSBN/PSBN	90°	75°	0.225 x (R-R')	-0.293 x (R-R')

Example : Compensation when changing corner-R from 0.8 to 0.4, using PCLN toolholder,
 $\Delta X = 0.100 \times (0.8 - 0.4) = 0.04(\text{mm})$
 $\Delta Z = 0.100 \times (0.8 - 0.4) = 0.04(\text{mm})$

Turning (Cutting Time)

● Cutting Time (External Turning Case 1: 1 Pass machining)

- At Constant Revolution

$$T = \frac{60 \times L}{f \times n}$$

- At Constant Cutting Speed

$$T = \frac{60 \times \pi \times L \times D_m}{1,000 \times f \times V_c}$$

T : Cutting Time [sec]
L : Cutting Length [mm]
f : Feed Rate [mm/rev]
n : Spindle Revolution [min⁻¹]
D_m : Workpiece Dia. [mm]
V_c : Cutting speed [m/min]

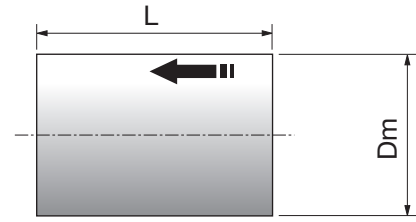

● Cutting Time (External Turning Case 2: Multi-Pass machining)

- At Constant Revolution

$$T = \frac{60 \times L}{f \times n} \times N$$

- At Constant Cutting Speed

$$T = \frac{60 \times \pi \times L \times (D_1 + D_2)}{2 \times 1,000 \times f \times V_c} \times N$$

T : Cutting Time [sec]
L : Cutting Length per Pass [mm]
ap : Depth of Cut per Pass [mm]
f : Feed Rate [mm/rev]
n : Spindle Revolution [min⁻¹]
D₁ : Max. Dia. of Workpiece [mm]
D₂ : Min. Dia. of Workpiece [mm]
V_c : Cutting speed [m/min]
N : Number of Passes = (D₁ - D₂) / ap / 2 (if it is indivisible, obtain integer by rounding up one place of decimals.)

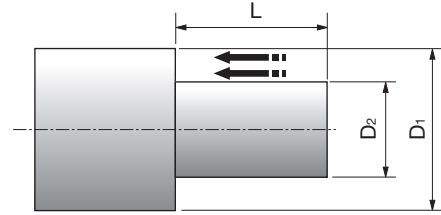

● Cutting Time (Facing)

- At Constant Revolution

$$T = \frac{60 \times (D_1 - D_2)}{2 \times f \times n} \times N$$

- At Constant Cutting Speed

$$T_1 = \frac{60 \times \pi \times (D_1 + D_2) \times (D_1 - D_2)}{4,000 \times f \times V_c} \times N$$

T : Cutting Time [sec]
T₁ : Cutting Time before reaching
Max. Spindle Revolution [sec]
L : Cutting Length [mm]
ap : Depth of Cut per Pass [mm]
f : Feed Rate [mm/rev]
n : Spindle Revolution [min⁻¹]
D₁ : Max. Dia. of Workpiece [mm]
D₂ : Min. Dia. of Workpiece [mm]
V_c : Cutting speed [m/min]
N : Number of Passes = L / ap (if it is indivisible, obtain integer by rounding up one place of decimals.)

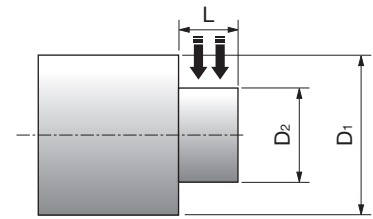

● Cutting Time (Grooving)

- At Constant Revolution

$$T = \frac{60 \times (D_1 - D_2)}{2 \times f \times n}$$

- At Constant Cutting Speed

$$T_1 = \frac{60 \times \pi \times (D_1 + D_2) \times (D_1 - D_2)}{4,000 \times f \times V_c}$$

T : Cutting Time [sec]
T₁ : Cutting Time before reaching
Max. Spindle Revolution [sec]
L : Cutting Length [mm]
f : Feed Rate [mm/rev]
n : Spindle Revolution [min⁻¹]
D₁ : Max. Dia. of Workpiece [mm]
D₂ : Min. Dia. of Workpiece [mm]
V_c : Cutting speed [m/min]

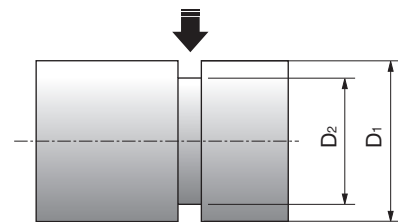

● Cutting Time (Cut-off)

- At Constant Revolution

$$T = \frac{60 \times D_1}{2 \times f \times n}$$

- At Constant Cutting Speed

$$T_1 = \frac{60 \times \pi \times (D_1 + D_3) \times (D_1 - D_3)}{4,000 \times f \times V_c}$$

$$T_3 = T_1 + \frac{60 \times D_3}{2 \times f \times n_{\max}}$$

T : Cutting Time [sec]
T₁ : Cutting Time before reaching
Max. Spindle Revolution [sec]
T₃ : Cutting Time when reaching
Max. Spindle Revolution [sec]
f : Feed Rate [mm/rev]
n : Spindle Revolution [min⁻¹]
n_{max} : Max. Spindle Revolution [min⁻¹]
D₁ : Max. Dia. of Workpiece [mm]
D₃ : Diameter when reaching Max. Spindle Revolution [mm]
V_c : Cutting speed [m/min]

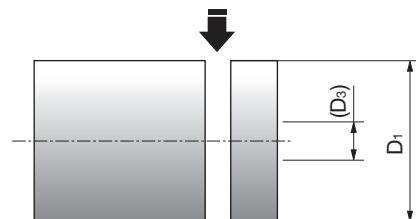

Basic Formulas

Milling

Cutting speed

$$V_c = \frac{\pi \times DC \times n}{1,000}$$

V_c : Cutting speed [m/min]

DC : Cutter Dia. [mm]

n : Spindle Revolution [min^{-1}]

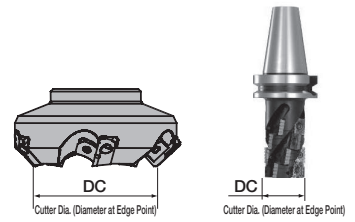

Table Feed & Feed per Tooth

$$f_z = \frac{V_f}{Z \times n}$$

f_z : Feed per Tooth [mm/t]

V_f : Table Feed [mm/min]

Z : No. of Inserts

n : Spindle Revolution [min^{-1}]

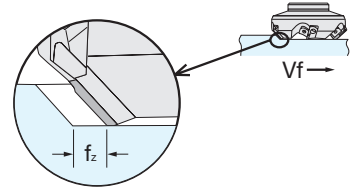

Power Requirement

$$P_c = \frac{K_s \times Q}{6,120 \times \eta} = \frac{K_s \times a_e \times V_f \times a_p}{6,120,000 \times \eta}$$

$$= \frac{K_s \times a_e \times f_z \times Z \times n \times a_p}{6,120,000 \times \eta}$$

$$P_{HP} = \frac{6,120}{4,500} \times P_c$$

P_c : Power Requirement [kW]

P_{HP} : Power Requirement (Horse Power) [HP]

a_e : Width of Cut [mm]

V_f : Table Feed [mm/min]

f_z : Feed per Tooth [mm/t]

Z : No. of Inserts

n : Spindle Revolution [min^{-1}]

a_p : Depth of Cut [mm]

K_s : Specific Cutting Force [kgf/mm²]

η : Mechanical Efficiency (0.7 ~ 0.8)

Q : Chip Removal Volume [$\text{cm}^3/\text{min}=\text{cc}/\text{min}$]

K_s [kgf/mm ²]	
Low Carbon Steel	190
Medium Carbon Steel	210
High Carbon Steel	240
Low Alloy Steel	190
High Alloy Steel	245
Cast Iron	93
Malleable Cast Iron	120
Bronze, Brass	70

Chip Removal Volume

$$Q = \frac{a_e \times V_f \times a_p}{1,000} = \frac{a_e \times f_z \times Z \times n \times a_p}{1,000}$$

Q : Chip Removal Volume [$\text{cm}^3/\text{min}=\text{cc}/\text{min}$]

a_e : Width of Cut [mm]

V_f : Table Feed [mm/min]

f_z : Feed per Tooth [mm/t]

Z : No. of Inserts

n : Spindle Revolution [min^{-1}]

a_p : Depth of Cut [mm]

Cutting Time

$$T = \frac{60 \times L'}{V_f} = \frac{60 \times L'}{f_z \times Z \times n}$$

T : Cutting Time [sec]

L' : Total Table Transfer Length [mm]
($=L+DC+2a$)

L : Workpiece Length [mm]

DC : Cutter Dia. [mm]

a : Idling Distance [mm]

V_f : Table Feed [mm/min]

f_z : Feed per Tooth [mm/t]

Z : No. of Inserts

n : Spindle Revolution [min^{-1}]

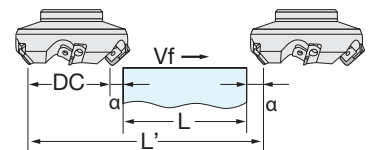

● True Rake Angle

$$\tan T = \tan R \times \cos C + \tan A \times \sin C$$

● Inclination Angle

$$\tan I = \tan A \times \cos C - \tan R \times \sin C$$

- A (GAMP) : Axial Rake Angle (A.R.) [°] (-90° < A < 90°)
- R (GAMF) : Radial Rake Angle (R.R.) [°] (-90° < R < 90°)
- C (KAPR) : Approach Angle [°] (0° < C < 90°)
- T (GAMN) : True Rake Angle [°] (-90° < T < 90°)
- I (GAMO) : Inclination Angle [°] (-90° < I < 90°)

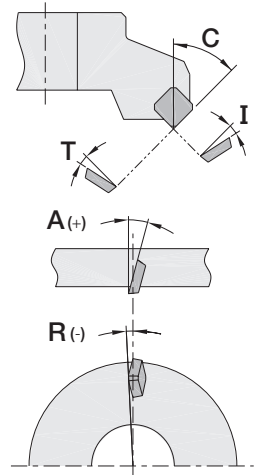

● Ball-Nose End Mill Cutting Speed & Revolution

$$n = \frac{1,000 \times V_a}{2 \times \pi \times \sqrt{a(2RE - a)}}$$

- n : Revolution [min⁻¹]
- RE : Radius of Ball-Nose End Mill (Ball Part's radius [mm])
- a_p : Depth of Cut [mm]
- V_a : Cutting Speed at Point "a" [m/min]

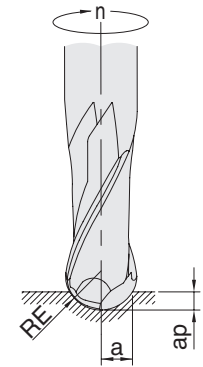

■ Drilling (Magic Drill Series)

● Cutting speed

$$V_c = \frac{\pi \times DC \times n}{1,000}$$

- V_c : Cutting speed [m/min]
- DC : Drill Dia. [mm]
- n : Spindle Revolution [min⁻¹]

● Feed Rate (Milling)

$$V_f = f_z \times Z \times n$$

- V_f : Table Feed [mm/min]
- f_z : Feed per Tooth [mm/t]
- Z : No. of Inserts (No. of Insert = 1)
- n : Spindle Revolution [min⁻¹]

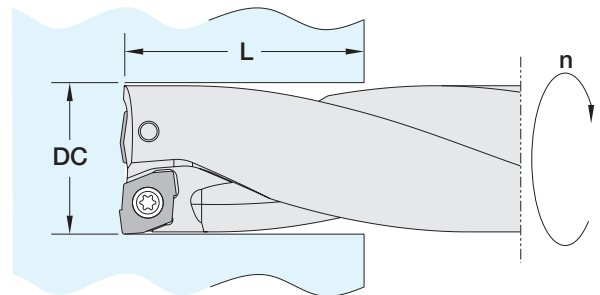

● Cutting Time

$$T = \frac{60 \times L}{f \times n} = \frac{60 \times \pi \times DC \times L}{1,000 \times V_c \times f}$$

- T : Cutting Time [sec]
- L : Drilling Depth [mm]
- f : Feed Rate [mm/rev]
- n : Spindle Revolution [min⁻¹]
- DC : Drill Dia. [mm]
- V_c : Cutting speed [m/min]

● Power Requirement (Reference Value)

$$P_c = \frac{DC}{20} \times \frac{V_c}{100} \times \left(1 + \left(\frac{2.5 \times f}{0.1} \right) \right)$$

- P_c : Power Requirement [kW]
- DC : Drill Dia. [mm]
- V_c : Cutting speed [m/min]
- f : Feed Rate [mm/rev]

Insert Grades	A
Turning Indexable Inserts	B
CBN & PCBN Tools	C
External	D
Small Parts Machining	E
Boring	F
Grooving	G
Cut-off	H
Threading	J
Drilling	K
Solid Tools	L
Milling	M
Tools for Turning Mill	N
Spare Parts	P
Technical Information	R
Index	T

Tooling Examples of Small Parts Machining

Tooling Example (1) CNC Automatic lathe (Gang Type)

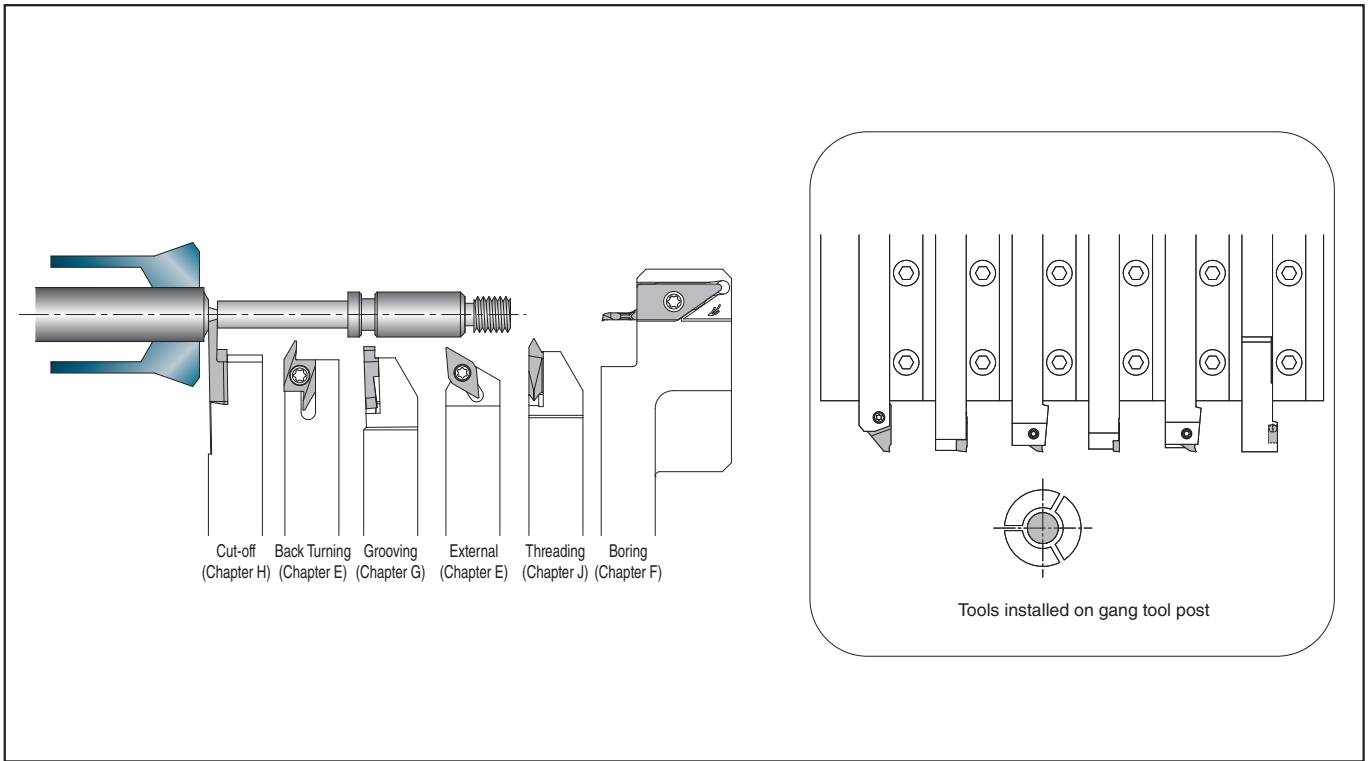

Tooling Example (2) CNC Automatic lathe (Gang Type)

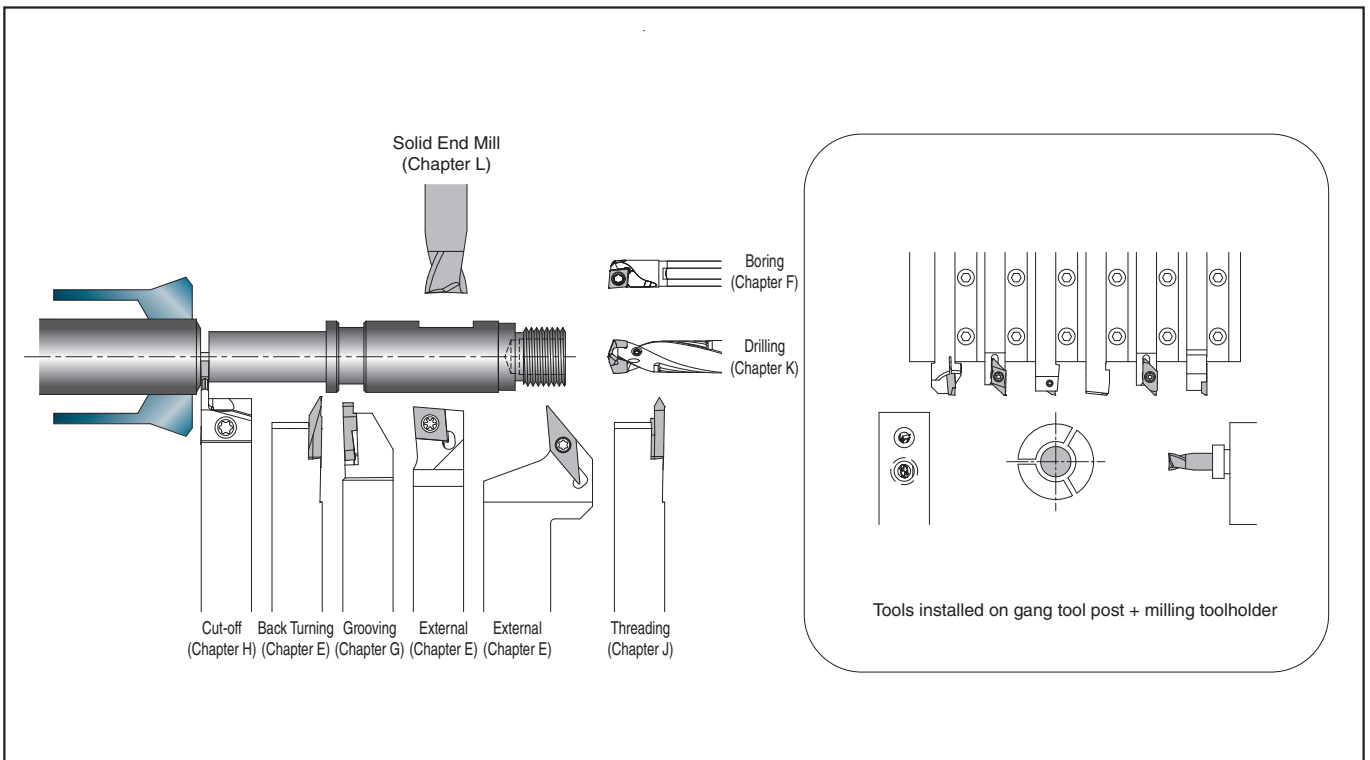

Tooling Example (3) CNC Automatic lathe (Opposed Gang Type)

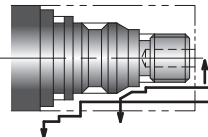
External / Facing

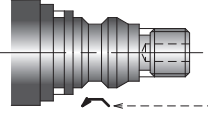
 (Chapter E)

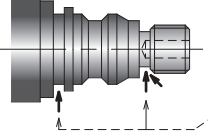
External / Copying

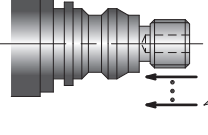
 (Chapter E)

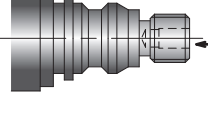
Grooving

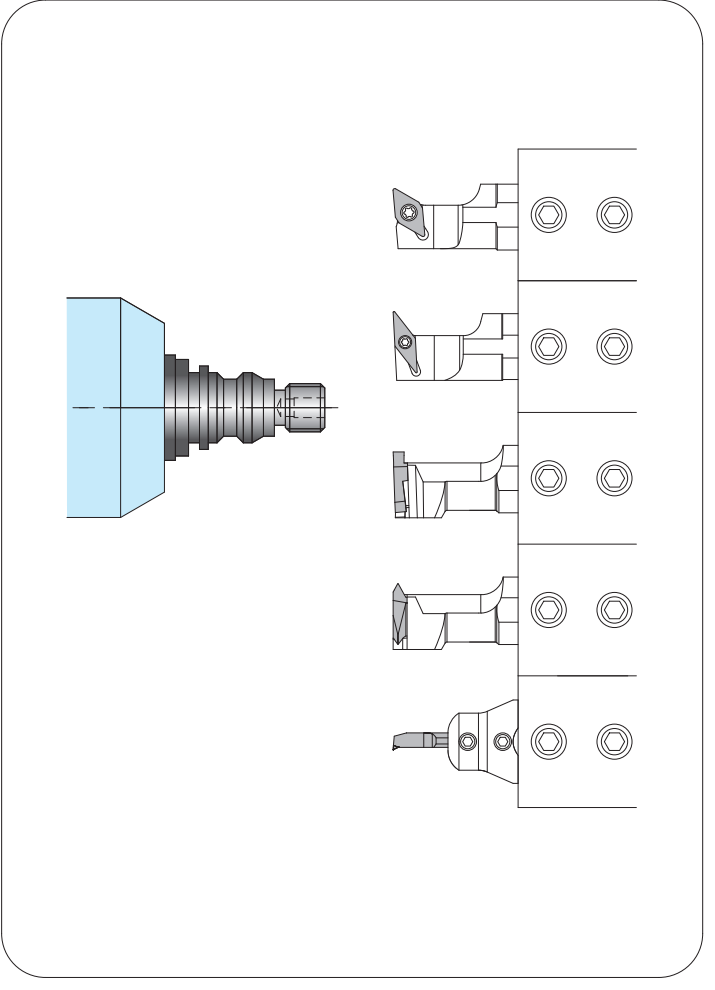
 (Chapter G)

Threading

 (Chapter J)

Boring

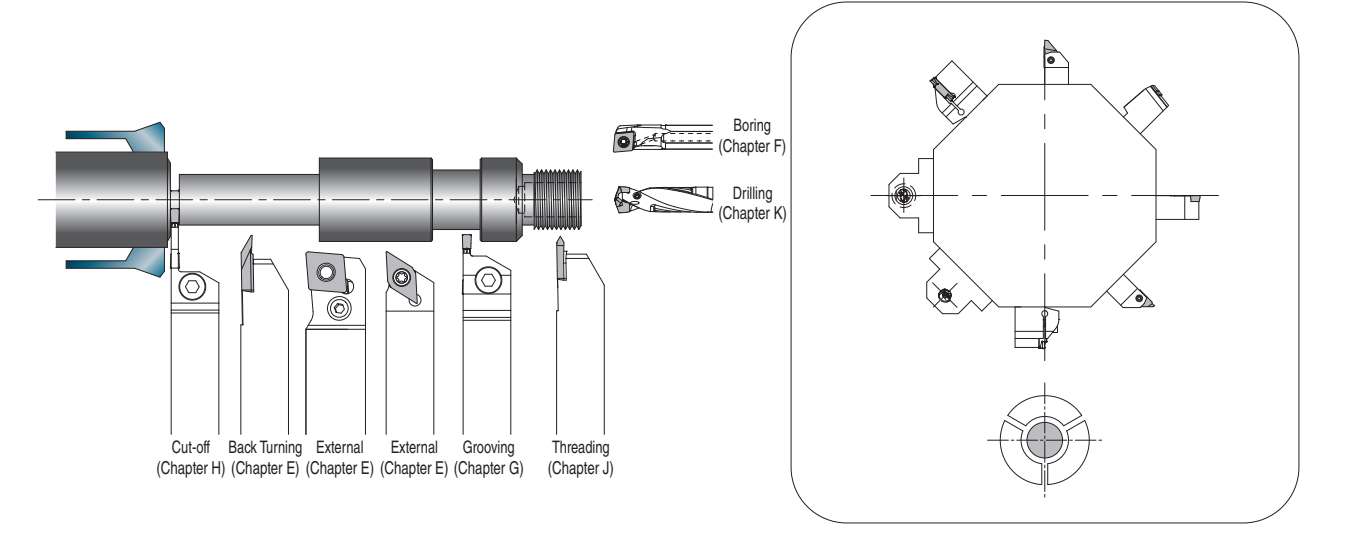
 (Chapter F)



Tooling Example (4) CNC Automatic lathe (Turret Type)



Boring (Chapter F)

Drilling (Chapter K)

Cut-off (Chapter H)

Back Turning (Chapter E)

External (Chapter E)

External (Chapter E)

Grooving (Chapter G)

Threading (Chapter J)

For Tooling Layout and Automatic Lathe List by Manufacturer, See Page [R44~R51](#)

Automatic Lathe List by Manufacturer

Citizen Machinery (Cincom Products)

Model	Toolholder Dimensions (Gang tool post)	Number of tools	Toolholder Dimensions (Turret tool post)	Number of tools	Sleeve Dia. (Horizontal/Opposed)	Number of tools	Max. Cutting Dia.	Remarks
A12/16	10 x 10 x 100	5			ø19.05/ø20		ø12/ø16	
A20	12(13) x 12(13) x 120 * Cut-off toolholder : □16mm	6			ø25.4		ø20	
A20VII	12(13) x 12(13) x 120 * Cut-off toolholder : □16mm	6			ø25.4		ø20	
A32	16 x 16 x 150	6			ø25.4		ø32	
B12	10 x 10 x 100	5			ø19.05/ø20		ø12	
B12E/B16E	10 x 10 x 120(60)	5			ø19.05(ø20 ^{OP})		ø12/ø16	
B20	12(13) x 12(13) x 120	6			ø19.05/ø20		ø20	
BL12	10 x 10 x 60 ~ 120	5			ø20(ø19.05)		ø12	
BL20/25	12(13) x 12(13) x 120	4 ~ 7			ø20(ø19.05)		ø20/ø25	
C12/16	10 x 10 x 120	6			ø19.05		ø12/ø16	
C32	16 x 16 x 130	5			ø25.4		ø32	
E16			10 x 10 x 60	20	ø19.05		ø16	
E20			16 x 16 x 90	20	ø25.4		ø20	
E25			16 x 16 x 90	20	ø25.4		ø25	
E32			16(19) x 16(13) x 90	20	ø25.4		ø32	
F10			10 x 10 x 60	10	ø19.05		ø10	
F12			10 x 10 x 60	10	ø19.05		ø12	
F16			10 x 10 x 60	10	ø19.05		ø16	
F20			16(19) x 16(13) x 90	10	ø25.4		ø20	
F25			16(19) x 16(13) x 90	10	ø25.4		ø25	
FL25			16 x 16 x 90	12	-		ø25	
FL42			16 x 16 x 90	12	-		ø42	
G32			16(19) x 16(19) x 90	10	-		ø32	
K12/16	12(10) x 12(10) x 100	6(7)			ø19.05/ø20		ø12/ø16	
K12E/K16E	12 x 12 x 120	6			ø19.05/ø20		ø12/ø16	
L10	8 x 8 x 100 ~ 130	5			ø15.875		ø10	
L12	10 x 10 x 100	6			ø19.05		ø12	
L16	12(10) x 12(10) x 130	5			ø19.05		ø16	
L20,L20E	12 x 12 x 130 * Cut-off toolholder : □16mm	5			ø19.05		ø20	
L20X,L220	12(13,16) x 12(13,16) x 120 * Cut-off toolholder : □16mm	5 ~ 7			ø19.05/ø25		ø20	
L25	16 x 16 x 130	5			ø25.4		ø25	
L32	16 x 16 x 130	5			ø25.4		ø32	
M₂12, M₃12	10 x 10 x 120	5	10 x 10 x 60	10 + α	ø19.05		ø12	
M₂16, M₃16	10 x 10 x 120	5	10 x 10 x 60	10 + α	ø19.05		ø16	
M₂20, M₃20	16 x 16 x 130	5	16 x 16 x 90	10 + α	ø25.4		ø20	
M₂32, M₃32, M₄32	16 x 16 x 130	5	16 x 16 x 90	10 + α	ø25.4		ø32	
M₄16	10 x 10 x 100	5	10 x 10 x 60	10 + α	ø19.05		ø16	
M20	13(12) x 13(12) x 130	5	10 x 10 x 60	10 + α	ø19.05		ø20	
MC20	12 x 12 x 120	2 + 2 + 2			ø19.05/ø20.0		ø20	
MSL12	10 x 10 x 120				-		ø12	
R04	8 x 8 x 120	5			ø15.875		ø4	
R07	8 x 8 x 120	5			ø15.875		ø7	
RL01	10(8) x 10(8) x 90				ø16(ø20)		ø10	
RL02	16 x 16 x 90				ø20		ø20	
RL21	10(12) x 10(12) x 90				ø19.05		ø35	

Manufacturers are in no particular order.

Citizen Machinery (Miyano Products)

Model	Toolholder Dimensions (Gang tool post)	Number of tools	Toolholder Dimensions (Turret tool post)	Number of tools	Sleeve Dia. (Horizontal/Opposed)	Number of tools	Max. Cutting Dia.	Remarks
ABX-51SY2			20 x 20 x 125(100)	24	ø25	48	ø51	
ABX-51SYY2			20 x 20 x 125(100)	24	ø25	48	ø51	
ABX-51TH5			20 x 20 x 125(100)	36	ø25	72	ø51	
ABX-51THY2			20 x 20 x 125(100)	36	ø25	72	ø51	
ABX-64SY2			20 x 20 x 125(100)	24	ø25	48	ø64	
ABX-64SYY2			20 x 20 x 125(100)	24	ø25	48	ø64	
ABX-64TH5			20 x 20 x 125(100)	36	ø25	72	ø64	
ABX-64THY2			20 x 20 x 125(100)	36	ø25	72	ø64	
BNA-34C			20 x 20 x 125(100)	8(16)	ø25	24	ø34	
BNA-34DHY			20 x 20 x 125(100)	14(22)	ø25	27	ø34	
BNA-34S			20 x 20 x 125(100)	8(16)	ø25	24	ø34	
BNA-42C/C2			20 x 20 x 125(100)	8(16)	ø25	24	ø42	
BNA-42DHY			20 x 20 x 125(100)	14(22)	ø25	27	ø42	
BNA-42DHY2			20 x 20 x 125(100)	14(22)	ø25	27	ø42	
BNA-42DHY3			20 x 20 x 125(100)	14(22)	ø25	27	ø42	
BNA-42GTY	20 x 20 x 125(100)	3	20 x 20 x 125(100)	8(16)	ø25	24(7)	ø42	
BNA-42MSY2			20 x 20 x 125(100)	8(16)	ø25	24	ø42	
BNA-42S/S2			20 x 20 x 125(100)	8(16)	ø25	24	ø42	
BNC-42C7			20 x 20 x 125(100)	8(16)	ø25	24	ø42	
BND-51C2			20 x 20 x 125(100)	12	ø25	24	ø51	
BND-51S2			20 x 20 x 125(100)	12	ø25	24	ø51	
BND-51SY2			20 x 20 x 125(100)	12	ø25	24	ø51	
BNE-42S6			20 x 20 x 125(100)	24	ø25	48	ø42	
BNE-42SY6			20 x 20 x 125(100)	24	ø25	48	ø42	
BNE-51S6			20 x 20 x 125(100)	24	ø25	48	ø51	
BNE-51SY6			20 x 20 x 125(100)	24	ø25	48	ø51	
BNE-51MSY			20 x 20 x 125(100)	24	ø25	48	ø51	
BNJ-34S3/S5			20 x 20 x 125(100)	18	ø25	30	ø34	
BNJ-34SY3/SY5			20 x 20 x 125(100)	18	ø25	30	ø34	
BNJ-42S3/S5			20 x 20 x 125(100)	18	ø25	30	ø42	
BNJ-42S6			20 x 20 x 125(100)	20	ø25	40	ø42	
BNJ-42SY3/SY5			20 x 20 x 125(100)	18	ø25	30	ø42	
BNJ-42SY5			20 x 20 x 125(100)	18	ø25	30	ø42	
BNJ-42SY6			20 x 20 x 125(100)	20	ø25	40	ø42	
BNJ-51S3/S5			20 x 20 x 125(100)	18	ø25	30	ø51	
BNJ-51SY3/SY5			20 x 20 x 125(100)	18	ø25	30	ø51	
BNJ-51SY6			20 x 20 x 125(100)	20	ø25	40	ø51	
GN-3200	12(16) x 12(16) x 70 ~ 120	4 ~ 5			ø20	4 ~ 5	ø40	
GN-3200W	12(16) x 12(16) x 70 ~ 120	4 ~ 5			ø20	4 ~ 5	ø40	
GN-4200	12(16) x 12(16) x 70 ~ 120	7 ~ 8			ø20	7 ~ 8	ø40	
LX-06E2			20 x 20 x 125(100)	8	ø32	8		6 inch power chuck
LX-06E3			20 x 20 x 125(100)	8	ø32	8		6 inch power chuck
LX-08C			25 x 25 x 150	10	ø40	10		8 inch power chuck
LX-08E2			25 x 25 x 150	8	ø40	8		8 inch power chuck
LX-08E3			25 x 25 x 150	8	ø40	8		8 inch power chuck
LX-08R			20 x 20 x 125(100)	10	ø25	20		8 inch power chuck
LZ-01R2			20 x 20 x 125(100)	12	ø25	24		6 inch power chuck
LZ-01RY2			20 x 20 x 125(100)	12	ø25	24		6 inch power chuck
LZ-02R2			20 x 20 x 125(100)	10	ø25	20		8 inch power chuck
LZ-02RY2			20 x 20 x 125(100)	10	ø25	20		8 inch power chuck
RL01Ⅲ	10 x 10 x 70 ~ 120	2 ~ 3			ø16	2 ~ 3	ø10	
RL01Ⅴ	10 x 10 x 70 ~ 120	2 ~ 3			ø16	2 ~ 3	ø10	
RL03	12(16) x 12(16) x 70 ~ 120	4 ~ 5			ø20	4 ~ 5	ø40	
VC03	12(16) x 12(16) x 70 ~ 120	4 ~ 5			ø20	4 ~ 5	ø40	

* Number of tools shown in parentheses is the maximum number of toolholder mountable including ø25 sleeves.

Manufacturers are in no particular order.

Insert Grades

Turning

Indexable Inserts

CBN & PCD Tools

External

Small Parts

Machining

Boring

Grooving

Cut-off

Threading

Drilling

Solid Tools

Milling

Tools for

Turning Mill

Spare Parts

Technical

Information

Index

A

B

C

D

E

F

G

H

J

K

L

M

N

P

R

T

Automatic Lathe List by Manufacturer

Star Micronics

Model	Toolholder Dimensions (Gang tool post)	Number of tools	Toolholder Dimensions (Turret tool post)	Number of tools	Sleeve Dia. (Horizontal/Opposed)	Number of tools	Max. Cutting Dia.	Remarks
ECAS-12	10 x 10 x 95 ~ 150	6			ø22	4/4	ø13	
ECAS-20T			16 x 16 x 60 ~ 78(80 ~ 88)		ø22/ø32		ø20	
ECAS-32T			16 x 16 x 60 ~ 78(80 ~ 88)	10	ø22/ø32		ø32	
JNC-10			8 x 8 x 65	6			ø10	
JNC-16			10 x 10 x 80	6			ø16	
JNC-25/32			10 x 10 x 78 ~ 120	10	ø22		ø25/ø32	
KJR-16B/25B			16 x 16 x 78	12/16	ø22/ø32		ø16/ø25	
KNC-16/20			16 x 16 x 68	16	ø22		ø16/ø20	
KNC-25II/32II			16 x 16 x 78	20	ø22/ø32		ø25/ø32	
RNC-10	10 x 10 x 80 ~ 120	5			ø22		ø10/ø10	
RNC-16	10 x 10 x 80 ~ 120	5			ø22		ø16	
SA-16R	10 x 10 x 95 ~ 120	6			ø22	4/4	ø16	
SB-16 (A/C/D/E)	12 x 12 x 95 ~ 130	5			ø22/(ø22)	4/4	ø16	Only D/E for back clamp sleeves
	12(10) x 12(10) x 95 ~ 130	6			ø22/(ø22)	4/4	ø16	
SB-12II(C/E)	12 x 12 x 95 ~ 130	6			ø22/(ø22)	4/4	ø13	Only E for back clamp sleeves
SB-16II(C/E)	12(10) x 12(10) x 95 ~ 130	6			ø22/(ø22)	4/4	ø16	
SB-20 A/C/E	12 x 12 x 95 ~ 130	6			ø22/ø22	4/4	ø20	
SB-12R typeG	12 x 12 x 95 ~ 130	6			ø22/ø22	4/4	ø13	
	10 x 10 x 95 ~ 130	7			ø22/ø22	4/4		
SB-16R/20R typeN	12 x 12 x 95 ~ 130	6			ø22/ø22	4/4	ø16/ø23	
	10 x 10 x 95 ~ 130	7			ø22/ø22	4/4		
SB-16R/20R typeG	12 x 12 x 95 ~ 130	6			ø22/ø22	4/4	ø16/ø23	
	10 x 10 x 95 ~ 130	7			ø22/ø22	4/4		
SC20	12 x 12 x 95 ~ 130	5			ø22/-	4/4	ø20	
	10 x 10 x 95 ~ 130	6				4/4	ø20	
SE-12B/16B	10 x 10 x 95 ~ 120	5			ø22	3/3	ø13/ø16	
SG-42			16 x 16 x 84 ~ 88(71 ~ 82) 20 x 20 x 84 ~ 88		ø22/ø32		ø42	
SH-7	8 x 8 x 95 ~ 120	5			ø22	3	ø7	
SH-12/16	10 x 10 x 95 ~ 120	5			ø22	3	ø13/ø16	
SI-12/12C	10 x 10 x 80 ~ 130	6			ø22	3	ø13	
SR-10J	8 x 8 x 67 ~ 110 (Spacer is needed)	6			ø16	4	ø10	
SR-20RII	12 x 12 x 100 ~ 135	6		4	ø22/ø22	4/4	ø23	
SR-20RIII	12 x 12 x 95 ~ 135	6			ø22/ø22	6/4	ø23	Toolpost for 2 toolholders (deep boring) on the front side
SR-20J typeC	12 x 12 x 95 ~ 135	6			ø22/ø22	6/4	ø23	
SR-20J typeN	12 x 12 x 95 ~ 135	6			ø22/ø22	6/4	ø23	
SR-20IVtypeA	12 x 12 x 100 ~ 130	7			ø22/ø22	6/6	ø23	
SR-20IVtypeB	12 x 12 x 100 ~ 130	7			ø22/ø22	6/8	ø23	
SR-25J/32J	16 x 16 x 95 ~ 155	6		4	ø22+ø32/ø22	4/4	ø32	
SR-32JIItypeA	16 x 16 x 95 ~ 165	6			ø22+ø32/ø22	5/8	ø34	
SR-32JIItypeB	16 x 16 x 95 ~ 165	6			ø22+ø32/ø22	5/8	ø34	
SR-38typeA	16 x 16 x 95 ~ 135	4			ø22+ø32	5/8	ø38	
	16 x 16 x 100	2						
SR-38typeB	16 x 16 x 95 ~ 135	4			ø22+ø32	5/8	ø38	
	16 x 16 x 100	2						
	20 x 20 x 105 ~ 135(Cut-off)	1						
ST-20			12 x 12 x 73 ~ 79		ø22/ø32		ø20	
			12 x 12 x 65 ~ 73 (Cut-off)					
			16 x 16 x 64 ~ 73					
			16 x 16 x 65 ~ 73 (Cut-off)					
ST-38			16 x 16 x 83 ~ 88		ø22/ø32		ø38	
			16 x 16 x 71 ~ 82					
			16 x 16 x 84 ~ 88 (Cut-off)					
			20 x 20 x 84 ~ 88					
			20 x 20 x 84 ~ 88 (Cut-off)					
SV-20R	12 x 12 x 95 ~ 135	7	12 x 12 x 70 ~ 78		ø22/ø32	- / 8	ø23	
	16 x 16 x 95 ~ 135	6	16 x 16 x 65 ~ 70					
SV-38R	16 x 16 x 105 ~ 135	4	16 x 16 x 84 ~ 88		ø22/ø32	- / 8	ø38	
	20 x 20 x 115 ~ 135 (Cut-off)	1	16 x 16 x 71 ~ 82					
			20 x 20 x 84 ~ 88					
SV-12/20	12 x 12 x 95 ~ 135	5	12 x 12 x 70 ~ 78		ø22/ø32		ø12/ø20	
	16 x 16 x 95 ~ 135	4	16 x 16 x 65 ~ 70					
SV-32	16 x 16 x 95 ~ 135	4	16 x 16 x 60 ~ 78 (80 ~ 88)		ø22/ø32		ø32	
SW-7	8 x 8 x 80 ~ 120	6				4/4	ø7	
SW-12RII	10 x 10 x 95 ~ 115	7			ø16/ø16+ø22	4/8	ø13	
SW-20	12 x 12 x 80 ~ 150	6			ø22	4/8	ø23	
	16 x 16 x 80 ~ 144							

Manufacturers are in no particular order.

Tsugami

Model	Toolholder Dimensions (Gang tool post)	Number of tools	Toolholder Dimensions (Turret tool post)	Number of tools	Sleeve Dia. (Horizontal/Opposed)	Number of tools	Max. Cutting Dia.	Remarks
B0123-III	12 x 12 x 85	9	-	-	ø20/-	4/-	ø12	
B0124/125/126-III	12 x 12 x 85	9	-	-	ø20/ø20	4/4	ø12	
B0128W	12 x 12 x 85	9	-	-	ø20/ø20	4/4	ø12	
B0203-III	12 x 12 x 85	9	-	-	ø20/ø20	4/4	ø20	
B0204/205/206-III	12 x 12 x 85	9	-	-	ø20/ø20	4/4	ø20	
B0208W	12 x 12 x 85	9	-	-	ø20/ø20	4/4	ø20	
B020M-II	-	-	-	-	-/ø20	-/1	ø20	
BW207J	12 x 12 x 85/16 x 16 x 85	5/2	-	-	ø20/ø20	5/4	ø20	
BW208J	12 x 12 x 85/16 x 16 x 85	5/2	-	-	ø20/ø20	5/4	ø20	
BW208ZJ	12 x 12 x 85/16 x 16 x 85	5/2	-	-	ø20/ø20	5/4	ø20	
BW209ZJ	12 x 12 x 85/16 x 16 x 85	5/2	-	-	ø20/ø20	5/4	ø20	
B0265/265B/266-II	16 x 16 x 100	12	-	-	ø25/ø25	5/4	ø26	
B0325/325B/326-II	16 x 16 x 100	12	-	-	ø25/ø25	5/4	ø32	
B0385/385L	20 x 20 x 125	8	-	-	ø32/ø32	3/5	ø38	
B038T	-	-	20 x 20 x 125	St.8	ø32/ø25	-	ø38	
B073-III	8 x 8 x 85	9	-	-	ø20	4	ø7	
B074/075-III	8 x 8 x 85	9	-	-	ø20/ø20	4/4	ø7	
BH20/BH20Z	12 x 12 x 85	4	12 x 12 x 85	St.12	ø25/ø32	-	ø20	
BH38	16 x 16 x 125	5	20 x 20 x 125	St.12	ø25/ø32	-	ø38.1	
BM163-III	12 x 12 x 85	9	-	-	ø20/-	4/-	ø16	
BM164/165-III	12 x 12 x 85	9	-	-	ø20/ø20	4/4	ø16	
C150/CH154	12 x 12 x 60 ~ 100	4 ~ 6	-	-	-	-	ø80	
C180	12 x 12 x 60 ~ 100	4 ~ 6	-	-	-	-	ø120	
C220/220T	12 x 12 x 60 ~ 100	6 ~ 8	-	-	-	-	ø120	
C300-IV	16 x 16 x 100 ~ 130	6 ~ 10	-	-	-	-	ø165	
C300H	16 x 16 x 100 ~ 130	6 ~ 10	-	-	-	-	ø165	
P013	8 x 8 x 100 ~ 120	6	-	-	ø16/-	3/-	ø1	
P014	8 x 8 x 100 ~ 120	6	-	-	ø16/ø16	3/3	ø1	
P033	8 x 8 x 100 ~ 120	6	-	-	ø16/-	3/-	ø3	
P034	8 x 8 x 100 ~ 120	6	-	-	ø16/ø16	3/3	ø3	
S205/206	12 x 12 x 100	8	-	-	ø22/ø20	5/4	ø20	
SS207	12 x 12 x 100	8	-	-	ø22/ø20	4/4	ø20	
SS26	16 x 16 x 100	7	-	-	ø22/ø20	5/3	ø26	
SS32/32L	16 x 16 x 100	7	-	-	ø22/ø20	5/3	ø32	
SS20M	-	-	-	-	-/ø20	-/1	ø20	
SS267	16 x 16 x 100	8	-	-	ø25/ø25	4/4	ø26	
SS327	16 x 16 x 100	8	-	-	ø25/ø25	4/4	ø32	
MB25	-	-	20 x 20 x 90	2 x St.8	ø20/ø32	5/4	ø25	
M42J/M42SD	-	-	20 x 20 x 125	St.12	ø25/ø32	-	ø42	
M50J/M50SY-III	-	-	20 x 20 x 100	St.12	ø20/ø32	-	ø51	
M06JC	-	-	20 x 20 x 125	St.8	ø25	-	ø220/ø42	
M06J-II	-	-	25 x 25 x 150	St.8	ø32/ø40	-	ø260/ø51	
M08J-II	-	-	25 x 25 x 150	St.8	ø32/ø40	-	ø280/ø65	
M08JL5-II	-	-	25 x 25 x 150	St.8	ø32/ø40	-	ø280/ø65	
M06D-II	-	-	25 x 25 x 150	St.12	ø40	-	ø260/ø51	
M08D-II	-	-	25 x 25 x 150	St.12	ø40	-	ø280/ø65	
M06DY-II	-	-	25 x 25 x 150	St.12	ø40	-	ø260/ø51	
M08DY-II	-	-	25 x 25 x 150	St.12	ø40	-	ø280/ø65	
M06SD-II	-	-	25 x 25 x 150	St.12	ø40	-	ø260/ø51	
M08SD-II	-	-	25 x 25 x 150	St.12	ø40	-	ø280/ø65	
M06SY-II	-	-	25 x 25 x 150	St.12	ø40	-	ø260/ø51	
M08SY-II	-	-	25 x 25 x 150	St.12	ø40	-	ø280/ø65	
TMU1	20 x 20 x 100 ~ 125	1	20 x 20 x 125	St.16	ø32/ø32	-	ø38	
TMB2	20 x 20 x 100 ~ 125	1	20 x 20 x 125	St.16	ø32/ø32	-	ø51	
TMA8-IV	20 x 20 x 100 ~ 125	1	-	-	ø32/ø32	-	ø65	
TMA8J	20 x 20 x 100 ~ 125	1	-	-	ø32/ø32	-	ø65	
TMA8H	20 x 20 x 100 ~ 125	1	-	-	ø32/ø32	-	ø65	

Manufacturers are in no particular order.

Insert Grades
Indexable Inserts
Turning
CNC & PCO Tools
External
Small Parts
Machining
Boring
Grooving
Cut-off
Threading
Drilling
Solid Tools
Milling
Tools for
Turning Mill
Spare Parts
Technical Information
Index

A
B
C
D
E
F
G
H
J
K
L
M
N
P
R
T

Automatic Lathe List by Manufacturer

Nomura DS

Model	Toolholder Dimensions (Gang tool post)	Number of tools	Toolholder Dimensions (Turret tool post)	Number of tools	Sleeve Dia. (Horizontal/Opposed)	Number of tools	Max. Cutting Dia.	Remarks
NN-10C	10 x 10 x 130	6			ø17		ø10	
NN-10CS	10 x 10 x 130	5			ø17	4	ø10	
NN-10SII	10 x 10 x 130	5			ø23		ø10	
NN-10SB5	10 x 10 x 130	5			ø23		ø13	
NN-10T	10 x 10 x 130	7			ø23		ø10	
NN-16HIII	12 x 12 x 130	6			ø23		ø16	
NN-16J	12.7 x 12.7 x 130	6			ø23		ø16	
NN-16SB5	10 x 10 x 130	5			ø23		ø16	
NN-16SB6 Type1	12.7 x 12.7 x 130	7			ø17(ø22)	4	ø16	
NN-16SB6 Type2	12.7 x 12.7 x 130	5			ø17(ø22)	4	ø16	
NN-16SB6 Type2.5	12.7 x 12.7 x 130	6			ø17(ø22)	5	ø16	
NN-16SB6 Type3	12.7 x 12.7 x 130	5			ø17(ø22)	4	ø16	
NN-16SB7	12.7 x 12.7 x 130	5			ø16	4	ø16	
NN-16UIII	12 x 12 x 130	5			ø23		ø16	
NN-16UB5	12 x 12 x 130	5			ø23		ø16	
NN-20CS	12.7 x 12.7 x 130	5(6)			ø22	4	ø20(ø25)	
NN-20HIII	12 x 12 x 130	6			ø23		ø20	
NN-20J	12.7 x 12.7 x 130	6			ø23		ø20	
NN-20J2	12.7 x 12.7 x 130	6			ø22	4	ø20	
NN-20UIII	12 x 12 x 130	5			ø23		ø20	
NN-20U5	12.7 x 12.7 x 150	5(6)			ø22	4	ø20(ø25)	
NN-20UB5	12 x 12 x 130	5			ø23		ø20	
NN-20UB7	12 x 12 x 130	6			ø23		ø20	
NN-20UB8	12.7 x 12.7 x 150	5(6)			ø22	4	ø20(ø25)	
NN-20YB	12 x 12 x 130	6			ø23		ø20	
NN-25YB/32YB	16 x 16 x 130	5			ø23/ø32		ø25/ø32	
NN-32UB8	16 x 16 x 130	2			ø22	3	ø32	
	12.7 x 12.7 x 150	3(4)			ø32	1		
NN-32YB2	16 x 16 x 130	5			ø22/ø32	4	ø32	
NN-32YB2 XB	16 x 16 x 130	6			ø22/ø32	5/1	ø32	

Manufacturers are in no particular order.

Eguro

Model	Toolholder Dimensions (Gang tool post)	Number of tools	Toolholder Dimensions (Turret tool post)	Number of tools	Sleeve Dia. (Horizontal/Opposed)	Number of tools	Max. Cutting Dia.	Remarks
SANAX-6	12 x 12	5 (MAX.)		5	ø16		ø15	
SANAX-8	16 x 16	5 (MAX.)		5	ø25/ø30		ø20	
	12 x 12	7 (MAX.)		5	ø25/ø30		ø20	
SANAX-10	16 x 16	5 (MAX.)		5	ø25/ø30		ø25.5	
EBN-10EX	12 x 12	6 (MAX.)			ø20		ø25.5	
NUCBOY-8EX	12 x 12	6 (MAX.)			ø20		ø20	
NUCLET-10EX	16 x 16	10 (MAX.)			ø20		ø25.5	
NUCPAL-10EX	16 x 16	10 (MAX.)			ø20		ø25.5	

Manufacturers are in no particular order.

List of Instruments and Applicable Small Parts Machining and Toolholders

Insert Grades
Turning
Indexable Inserts
CNC & PC Tools
External
Small Parts
Machining
Boring
Grooving
Cut-off
Threading
Drilling
Solid Tools
Milling
Tools for
Turning Mill
Spare Parts
Technical
Information
Index

A
B
C
D
E
F
G
H
J
K
L
M
N
P
R
T

List of Instruments and Applicable Small Parts Machining and Toolholders

Models of major machine tool manufacturers					
Manufacturer	Model (Automatic Lathe)	Toolholder Size	Total Length of Attached Toolholder (MAX.)	Applicable Toolholders	
Citizen Machinery	A12,A16,B12,L12,M416,RL01,RL21	10 x 10	100	...1010F-..	
	K12,K16	12 x 12		...1212F-..	
	RL02	16 x 16		...1616H-..	
	Citizen Machinery	B12E,B16E,BL12,C12,C16,M212,M216 M312,M316,MSL12	10 x 10	120	...1010JX-..
		A20,A20Ⅶ,B20,BL20,BL25,K12E,K16E L20X,L220	12 x 12		...1212JX-..
		L16,L20,L20E,M20	12 x 12	...1212JX-..	
	Star Micronics	C32,L25,L32,M220,M232 M320,M332,M432	16 x 16	130	...1616JX-..
RNC-10,RNC-16,SA-16R,SE-12B/16B SH-12/16,SW-12RⅡ		10 x 10	120	...1010JX-..	
SI-12,SI-12C		10 x 10	130	...1010JX-..	
SB-16A,SB-16C,SB-16D,SB-12Ⅱ SB-16Ⅱ,SB-12R/16R/20R,SC20		12 x 12		...1212JX-..	
Star Micronics		SR-20RⅡ,SR-20Ⅲ,SV-12,SV-20,SR-20J SV-20R,SV-32,SV-32J,SV-32JⅡ,SV-38R	12 x 12	135	...1212JX-..
		ECAS-12	16 x 16		...1616JX-..
Star Micronics		ECAS-20	10 x 10	150	...1010JX-..
	SR-25J,SR-32J,SW-20	12 x 12	...1212JX-..		
Tsumami	B007	16 x 16	85	...1616JX-..	
	B0,BA,BC,BH20,BM,BS12,BS18,BS20 BU12,BU20,BW2	10 x 10		...1010F-..	
	C004,C150,C180,C220,S205,S206,S207	12 x 12	100	...1212F-..	
	BH38,BS26,BS32,BU26,BU38 SS26,SS32/32L,SS267,SS327	16 x 16		...1616H-..	
Nomura DS	NN-10C,NN-10CS,NN-10SⅡ NN-10SB5,NN-10SⅡ,NN-10T,NN-16SB5	10 x 10	130	...1010JX-..	
	NN-16HⅢ,NN-16UB5,NN-16UⅢ,NN-16J NN-20HⅢ,NN-20UⅢ,NN-20UB5,NN-20YB	12 x 12		...1212JX-..	
	NN-25YB,NN-32YB2 XB	16 x 16		...1616JX-..	

Manufacturers are in no particular order.

Parts Compatibility of Lever Lock Toolholders

Parts Compatibility of Lever Lock Toolholders

- 1) For better usability of lever lock toolholders, some levers, lock screws and shims are modified.
- 2) It is highly recommended to use only new parts. However, they are compatible with conventional parts and can be used together with them.
- 3) It is possible to use new parts only with a toolholder which has been in use.
- 4) When purchasing replacements, order them stating the new numbers.
- 5) Some of the shims remain unmodified.

Classification	See Page	Toolholder Description		Spare Parts						
				Lever		Lock Screw		Shim		
				New No.	Conventional	New No.	Conventional	New No.	Conventional	
External Toolholder	D9	PCLN [®] / _L-09	LL-1N	LL-1	LS-1N	LS-1	LC-32N	LC-32	
		-12	LL-2N	LL-2	LS-2N	LS-2	LC-42N	LC-42	
		-16	LL-5N	LL-5	LS-4N	LS-4	LC-53N	LC-53	
	D13	PDJN [®] / _L-11	LL-1DN	LL-1D	LS-1N	LS-1	LD-32N	LD-32	
		-15	LL-3N	LL-3	LS-2N	LS-2	LD-42		
	D14	PSBN [®] / _L-09	LL-1N	LL-1	LS-1N	LS-1	LS-32		
		-12	LL-2N	LL-2	LS-2N	LS-2	LS-42		
		PSKN [®] / _L-09	LL-1N	LL-1	LS-1N	LS-1	LS-32		
	D15	PSSN [®] / _L-12	LL-2N	LL-2	LS-2N	LS-2	LS-42		
		-09	LL-1N	LL-1	LS-1N	LS-1	LS-32		
		PSDNN-09	LL-1N	LL-1	LS-1N	LS-1	LS-32		
	D16	PTGN [®] / _L	1212F-11	LL-03N	LL-03	LS-03N	LS-03	-		
		-11	LL-03TN	LL-03T	LS-03SN	LS-03S	-		
		-16	LL-1N	LL-1	LS-1N	LS-1	LT-32N	LT-32	
		-22	LL-2N	LL-2	LS-2N	LS-2	LT-42N	LT-42	
			PTFN [®] / _L	1212F-11	LL-03N	LL-03	LS-03N	LS-03	-	
	-11	LL-03TN	LL-03T	LS-03SN	LS-03S	-			
	-16	LL-1N	LL-1	LS-1N	LS-1	LT-32N	LT-32		
	-22	LL-2N	LL-2	LS-2N	LS-2	LT-42N	LT-42		
		D21	PRGC [®] / _L-12	LL-1CN	LL-1C	LS-1N	LS-1	LR-12C	
			PRXC [®] / _L-12						
	PRGN [®] / _L	-09	LL-1N	LL-1	LS-1N	LS-1	LR-80		
	D22	PWLN [®] / _L-12	LL-2N	LL-2	LS-2N	LS-2	LR-81		
		-06	LL-1N	LL-1	LS-1N	LS-1	LW-32N	LW-32	
....-08			LL-2N	LL-2	LS-2N	LS-2	LW-42N	LW-42		
Boring Bars	F70	<input type="checkbox"/> 16M- PCLN [®] / _L	09-20	LL-03SN	LL-03S	LS-03SN	LS-03S	-		
		<input type="checkbox"/> 20Q- PCLN [®] / _L	09-27	LL-1N	LL-1	LS-1SN	LS-1S	LC-32N	LC-32	
		<input type="checkbox"/> 25R- PCLN [®] / _L	09-32							
- PCLN [®] / _L	12-..	LL-2N	LL-2	LS-2N	LS-2	LC-42N [®] / _L	LC-42 [®] / _L		
	F71- PDUN [®] / _L	11-..	LL-1DN	LL-1D	LS-1SN	LS-1S	LD-32N	LD-32	
	F77- PTUN [®] / _L	11-..	LL-03TN	LL-03T	LS-03SN	LS-03S	-		
		S25R- PTUN [®] / _L	16-30	LL-03SN	LL-03S	LS-03SN	LS-03S	-		
		S32S- PTUN [®] / _L	16-40	LL-1N	LL-1	LS-1N	LS-1	LT-32N	LT-32	
	F78	S40T- PTUN [®] / _L	16-50							
		<input type="checkbox"/> 16M- PWLN [®] / _L	06-20	LL-03SN	LL-03S	LS-03SN	LS-03S	-		
<input type="checkbox"/> 20Q- PWLN [®] / _L		06-27	LL-1N	LL-1	LS-1SN	LS-1S	LW-32N	LW-32		
F80	<input type="checkbox"/> 25R- PWLN [®] / _L	06-32								
Turning Mill	N13- PWLN [®] / _L	08-..	LL-2N	LL-2	LS-2N	LS-2	LW-42N [®] / _L	LW-42 [®] / _L	
		T63H- PCLN [®] / _L	-DX12	LL-2N	LL-2	LS-2N	LS-2	LC-42N	LC-42	
		T63H- PCMNN	- <input type="checkbox"/> 12							
	N14	T63H- PDJN [®] / _L	-DX15	LL-3N	LL-3	LS-2N	LS-2	LD-42		
		T63H- PDNNN	- <input type="checkbox"/> 15							
N15	T63H- PTGN [®] / _L	-DX16	LL-1N	LL-1	LS-1N	LS-1	LT-32N	LT-32		
	T63H- PWLN [®] / _L	-DX08	LL-2N	LL-2	LS-2N	LS-2	LW-42N	LW-42		